

TEM®

Fiyat
Listesi
2024

İÇİNDEKİLER

- 2** ● Monofoze Prizler
Monofaze Kauçuk Fiş & Prizler
- 3** ● Ray Tipi Monofaze Prizler
- 4** ● Trifaze Kauçuk Fiş & Prizler
- 5-7** ● Modüler Prizler
Blok Prizler
- 8** ● IEC Soketler
- 9-10** ● Şarj Cihazları
Gerilim Koruma (SPD)
- 11** ● Faceplate - Konnektörler
- 12** ● Döşeme Altı / Boşluk Kapakları
- 13-14** ● Multimedya Soketler
- 15** ● Akım Koruma Cihazları
On - Off Anahtarlar
- 16** ● WIFI Akıllı Priz
- 17-18** ● 1U Prizler
- 19** ● 1U GST PDU
- 20** ● U62 PDU
- 21-22** ● U42 -W42 PDU
- 23** ● G70 Masaüstü PDU
- 24-25** ● Kolon Grubu
- 26** ● Masa Kapağı
Masaüstü Gömme Priz
- 27** ● O44 PDU
- 28** ● Gömme Prizler
- 29** ● Güç Çerçevesi
- 30** ● Kapaklı Güç Çerçevesi
- 31** ● Yatay Masa Grubu
- 32-36** ● Aydınlatma Grubu
Lineer Aydınlatma
Prizli Aydınlatma
- 37** ● Döşeme Altı Buat - Priz Kutuları
- 38** ● Alüminyum Gövdeli Masa Grupları
Dahili Priz Kutuları
- 39-47** ● Cee Norm Prizler
Çoklayıcılar
İçten Kilitli Şalterli Prizler
- 48** ● Mbox
- 49-54** ● Kombinasyon Kutuları
- 55** ● Taşıyıcı Ayak
- 56** ● Buat
- 57-61** ● Plastik Panolar
- 62-65** ● Kablo Makaraları
- 66** ● Acil Aydınlatma
- 67** ● Seyyar Lamba / Baladoz
- 68** ● Kablolar
Kablo Bağları

Monofaze Prizler

16A

2P+E

200-250 V~

Tek Terminal

Tek Terminal IP54

Çift Terminal IP54



212.310.110.001.8
Şebeke Pano Prizi
80,00 TL



215.310.112.001.8
Şebeke Pano Prizi
86,00 TL



215.320.112.001.2
UPS Pano Prizi
96,00 TL



215.310.212.001.6
Şebeke Pano Prizi
89,00 TL



215.320.212.001.2
UPS Pano Prizi
99,00 TL



440.116.160
IP44
Eğik Makine Prizi
108,00 TL



670.116.160
IP67 Kilitli Kapaklı
Eğik Makine Prizi
150,00 TL



440.116.150
IP44
Makine Prizi
108,00 TL



440.116.151
IP44 Dik Kasalı
Duvar Prizi
154,00 TL



440.116.152
IP44 Eğik Kasalı
Duvar Prizi
168,00 TL



440.116.153
IP44 Eğik Kasalı Duvar Prizi
+ Monofaze Pano Prizi
240,00 TL



Monofaze Kauçuk Fiş & Prizler

16A

2P+E

200-250 V~



215.116.200
Uzatma Prizi
110,00 TL



215.116.301
Düz Uzun Fiş
73,00 TL



215.116.300 | 215.316.300
Şebeke Düz Fiş | UPS Düz Fiş
73,00 TL | 85,00 TL



215.116.320 | 215.316.320
Şebeke Eğik Fiş | UPS Eğik Fiş
75,00 TL | 80,00 TL



215.116.101
Tekli Priz
165,00 TL



215.116.102
İkili Grup Priz
240,00 TL



215.116.103
Üçlü Grup Priz
250,00 TL



215.116.104
Dörtlü Grup Priz
315,00 TL





TEM RAY PRİZLERİ

Standart Sigorta Rayına Uygun Prizler

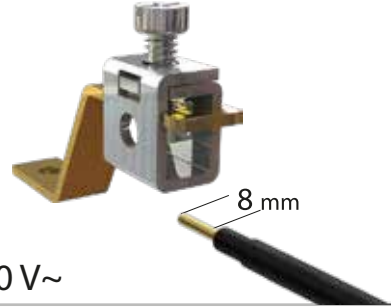

Ray Tipi Monofaze Prizler

2P+E

200-250 V~



Şebeke Prizi

272.313.110.011.8

220,00 TL



Şebeke Prizi Ledsiz

272.313.110.001.8

190,00 TL



UPS Prizi

272.323.110.011.8

250,00 TL



UPS Prizi Ledsiz

272.323.110.001.8

220,00 TL

Trifaze Fiş & Prizler 4x25 A

25A

380-415 V~



540.425.300 
Fiş
110,00 TL



540.425.200 
Uzatma Prizi
170,00 TL



540.425.110 
Duvar Prizi Klemensli
190,00 TL



540.425.111 
1 Ad. Trifaze + 1 Ad. Monofaze
Grup Priz
370,00 TL



540.425.121 
2 Ad. Trifaze + 1 Ad. Monofaze
Grup Priz
560,00 TL



540.425.112 
1 Ad. Trifaze + 2 Ad. Monofaze
Grup Priz
530,00 TL



540.425.130 
3 Ad. Trifaze
Grup Priz
580,00 TL



540.425.150 
Pano Prizi
160,00 TL



540.425.151 
Dik Kasalı Duvar Prizi
230,00 TL



540.425.152 
Eğik Kasalı Duvar Prizi
250,00 TL



540.425.153 
Eğik Kasalı Duvar Prizi
+ Monofaze Pano Prizi
420,00 TL

Trifaze Prizler 3x16 A

16A

IP44

380-415 V~



544.316.300 
Fiş
230,00 TL



544.316.150 
Pano Prizi
190,00 TL



544.316.151 
Dik Kasalı Duvar Prizi
240,00 TL



544.316.152 
Eğik Kasalı Duvar Prizi
265,00 TL



544.316.153 
Eğik Kasalı Duvar Prizi
+ Monofaze Pano Prizi
435,00 TL

Trifaze Prizler 3x32 A

32A

IP44

380-415 V~



544.332.300 
Fiş
315,00 TL



544.332.150 
Pano Prizi
235,00 TL



544.332.151 
Dik Kasalı Duvar Prizi
270,00 TL



544.332.152 
Eğik Kasalı Duvar Prizi
310,00 TL



544.332.153 
Eğik Kasalı Duvar Prizi
+ Monofaze Pano Prizi
500,00 TL

Tek Terminalli Prizler

252.311.120.001.9
Tırnaklı Tek Terminalli
Şebeke Prizi 45°
76,00 TL



252.321.120.001.2
Tırnaklı Tek Terminalli
UPS Prizi 45°
86,00 TL



252.311.110.001.9
Tırnaklı Tek Terminalli Şebeke Prizi
76,00 TL



252.321.110.001.2
Tırnaklı Tek Terminalli UPS Prizi
86,00 TL

Çift Terminalli Prizler

252.311.220.001.9
Tırnaklı Çift Terminalli
Şebeke Prizi 45°
89,00 TL



252.321.220.001.2
Tırnaklı Çift Terminalli
UPS Prizi 45°
99,00 TL



252.311.210.001.9
Tırnaklı Çift Terminalli
Şebeke Prizi
89,00 TL



252.321.210.001.2
Tırnaklı Çift Terminalli
UPS Prizi
99,00 TL

Çift Tırnaklı Çift Terminalli Prizler

252.312.220.101.9
Çift Tırnaklı Çift Terminalli
Şebeke Prizi 45°
95,00 TL



252.322.220.101.2
Çift Tırnaklı Çift Terminalli
UPS Prizi 45°
105,00 TL



252.312.210.001.9
Çift Tırnaklı Çift Terminalli
Kapaklı Şebeke Prizi
120,00 TL



252.322.210.001.2
Çift Tırnaklı Çift Terminalli
Kapaklı UPS Prizi
130,00 TL



252.310.120.001.9
Vidalı Şebeke Prizi 45°
76,00 TL



252.320.120.001.2
Vidalı UPS Prizi 45°
86,00 TL

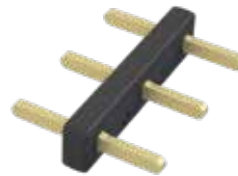

740.061.002
Priz Birleştirme Aparatı
40,00 TL



253.611.101.2
45x45mm Universal Priz
180,00 TL



253.711.101.2
45x45mm Amerikan Prizi
160,00 TL



253.811.101.2
45x45mm İngiliz Prizi
140,00 TL



253.411.101.2
51x45mm İngiliz Prizi
150,00 TL



721.130.300.2
İngiliz Fişi
170,00 TL



Tek Tırnaklı Tek Terminalli Fransız Prizler



252.351.110.001.2
Tırnaklı Tek Terminalli
Fransız Prizi 45°
99,00 TL



252.351.120.001.2
Tırnaklı Tek Terminalli
Fransız Prizi
99,00 TL



ŞEBEKE TİP

16A 2P+E 200-250 V~



	Açıklama	Ürün Kodu	B.Fiyat	Çocuk Emniyetli Kod	B.Fiyat
Kablolu	2'li Şebeke Prizi	262.31.132.002	144,00 TL	262.31.132.012	164,00 TL
	3'lü Şebeke Prizi	262.31.132.003	209,00 TL	262.31.132.013	239,00 TL
	4'lü Şebeke Prizi	262.31.132.004	274,00 TL	262.31.132.014	314,00 TL
Klemensli	2'li Şebeke Prizi	262.31.112.002	178,00 TL	262.31.112.012	198,00 TL
	3'lü Şebeke Prizi	262.31.112.003	243,00 TL	262.31.112.013	273,00 TL
	4'lü Şebeke Prizi	262.31.112.004	308,00 TL	262.31.112.014	348,00 TL
Çift Klemensli	2'li Şebeke Prizi	262.31.122.002	255,00 TL	262.31.122.012	275,00 TL
	3'lü Şebeke Prizi	262.31.122.003	320,00 TL	262.31.122.013	350,00 TL
	4'lü Şebeke Prizi	262.31.122.004	385,00 TL	262.31.122.014	425,00 TL

UPS TİP

16A 2P+E 200-250 V~



	Açıklama	Ürün Kodu	B.Fiyat	Çocuk Emniyetli Kod	B.Fiyat
Kablolu	2'li UPS Prizi	262.32.132.002	164,00 TL	262.32.132.012	184,00 TL
	3'lü UPS Prizi	262.32.132.003	239,00 TL	262.32.132.013	269,00 TL
	4'lü UPS Prizi	262.32.132.004	314,00 TL	262.32.132.014	354,00 TL
Klemensli	2'li UPS Prizi	262.32.112.002	198,00 TL	262.32.112.012	218,00 TL
	3'lü UPS Prizi	262.32.112.003	273,00 TL	262.32.112.013	303,00 TL
	4'lü UPS Prizi	262.32.112.004	348,00 TL	262.32.112.014	388,00 TL
Çift Klemensli	2'li UPS Prizi	262.32.122.002	275,00 TL	262.32.122.012	295,00 TL
	3'lü UPS Prizi	262.32.122.003	350,00 TL	262.32.122.013	380,00 TL
	4'lü UPS Prizi	262.32.122.004	425,00 TL	262.32.122.014	465,00 TL

FRANSIZ TİP

16A 2P+E 200-250 V~



	Açıklama	Ürün Kodu	B.Fiyat
Kablolu	2'li Fransız Prizi	262.35.132.002	188,00 TL
	3'lü Fransız Prizi	262.35.132.003	269,00 TL
	4'lü Fransız Prizi	262.35.132.004	348,00 TL
Klemensli	2'li Fransız Prizi	262.35.112.002	236,00 TL
	3'lü Fransız Prizi	262.35.112.003	300,00 TL
	4'lü Fransız Prizi	262.35.112.004	384,00 TL
Çift Klemensli	2'li Fransız Prizi	262.35.122.002	312,00 TL
	3'lü Fransız Prizi	262.35.122.003	384,00 TL
	4'lü Fransız Prizi	262.35.122.004	468,00 TL

BİLGİSAYAR IEC TİP 10A 2P+E 200-250 V~

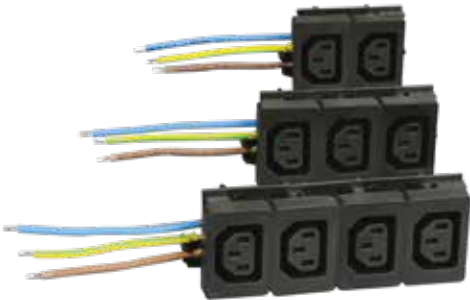

Açıklama	Ürün Kodu	B.Fiyat
2'li Bilgisayar Prizi	262.33.131.002	168,00 TL
3'lü Bilgisayar Prizi	262.33.131.003	204,00 TL
4'lü Bilgisayar Prizi	262.33.131.004	260,00 TL

İNGİLİZ TİP

13A 2P+E 200-250 V~

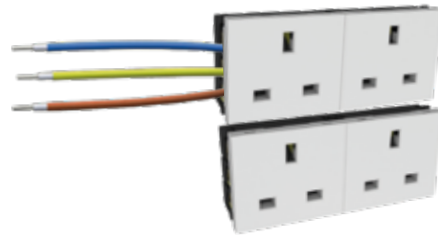

	Açıklama	Ürün Kodu	B.Fiyat
Kablolu	2'li İngiliz Prizi	262.38.131.002	216,00 TL
	3'lü İngiliz Prizi	262.38.131.003	252,00 TL
	4'lü İngiliz Prizi	262.38.131.004	336,00 TL
Çift Klemensli	2'li İngiliz Prizi	262.38.121.002	312,00 TL
	3'lü İngiliz Prizi	262.38.121.003	384,00 TL
	4'lü İngiliz Prizi	262.38.121.004	468,00 TL



720.130.150
IEC C13 10A
Tırnaklı Gövde Priz
39,00 TL



720.130.160
IEC C13 10A
Vidalı Gövde Priz
39,00 TL



720.130.200
IEC C13 10A
Uzatma Prizi
65,00 TL



720.140.320
IEC C14 10A
Tırnaklı Gövde Fiş
39,00 TL



720.140.340
IEC C14 10A
Vidalı Gövde Fiş
39,00 TL



720.140.300
IEC C14 10A
Uzatma Fişi
65,00 TL



720.140.321
IEC C14 10A
Gövdede Fiş
44,00 TL



720.190.150
IEC C19 16A
Tırnaklı Gövde Priz
113,00 TL



720.190.160
IEC C19 16A
Vidalı Gövde Priz
113,00 TL



720.190.200
IEC C19 16A
Uzatma Prizi
356,00 TL



720.200.320
IEC C20 16A
Tırnaklı Gövde Fiş
135,00 TL



720.240.340
IEC C20 16A
Vidalı Gövde Fiş
135,00 TL



720.200.300
IEC C20 16A
Uzatma Fişi
356,00 TL



720.200.321
IEC C20 16A
Gövdede Fiş
184,00 TL



Masaüstü kablosuz Şarj Modelleri



715.200.141
Giriş: 5V-2A -9V-2A
Çıkış: 15W/10W/7.5W/5W
İletim Mesafesi : Maks. 8mm
500,00 TL



X = 1 Siyah
X = 2 Gri

715.200.13X
Giriş: 5V-2A 9V-2A
Çıkış : 7.5W/10W/5W
İletim Mesafesi : Maks. 8mm
350,00 TL



715.200.151
Giriş: 5V 2A
USB Çıkış: 5V 1.5-2A
Kablosuz Şarj Çıkış : 5V 1A
1.000,00 TL

Masa altı kablosuz Şarj Modelleri

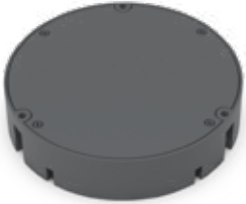

715.200.161
Giriş: 5V 2A - 9V 2A
Kablosuz Şarj Çıkış : 5W / 10W
İletim Mesafesi : 14mm
2.500,00 TL

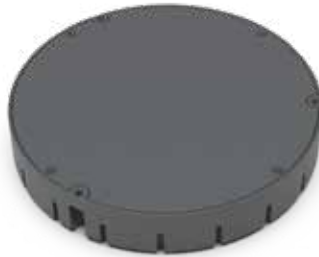

715.200.171
Giriş: 24V 1,5A
Kablosuz Şarj Çıkışı : 5W / 10W
İletim Mesafesi : 15mm - 30mm
4.000,00 TL

TEM | Hızlı Şarj Cihazı

715.200.120

1.180,00 TL

Tip: A/C

Toplam Güç: 30W

Tip A: 5V/3A, 9V/3A, 12V/2.5A, 20V/1.5A

Tip C: 5V/3A, 9V/3A, 12V/2.5A, 15V/2A, 20V/1.5A

Ölçü: 45x45x43mm



TEM | 22.5x45mm USB Şarj Cihazları

715.200.200

500,00 TL

Tip: A/A

Toplam Güç: 10.5W

DC 5.0V 2.1A

Ölçü: 22,5x45x41mm



715.200.210

625,00 TL

Tip: A/C

Toplam Güç: 10.5W

DC 5.0V 2.1A

Ölçü: 22,5x45x41mm



715.200.110

750,00 TL

Tip: A Anahtarlı

Toplam Güç: 10.5W

DC 5.0V 2.1A

Ölçü: 22,5x45x45mm



715.200.100

625,00 TL

Tip: A

Toplam Güç: 5W

DC 5.0V 1A

Ölçü: 22,5x45x37mm



TEM | 45x45mm USB Şarj Cihazları

715.100.100

825,00 TL

Tip: A/C

Toplam Güç: 10.5W

DC 5.0V 2.1A

Ölçü: 45x45x37mm



715.100.110

725,00 TL

Tip: A/A

Toplam Güç: 10.5W

DC 5.0V 2.1A

Ölçü: 22,5x45x37mm



temSPD | 0120 Tip Gerilim Koruma

734.612.0120.0

621,00 TL

U_c : 255V - 50-60 Hz

U_{oc} : 5/10 kV

I_n : 2,5/5 kA

U_p : $\leq 1,5$ kV

Ölçü: 22,5x45x36mm



Not: Ürünün üzerindeki gösterge ışığı
Yeşil yanıyor ise, ürünün normal çalıştığı,
Kırmızı yanıyor ise, ürünün değiştirilmesi gerektiği
anlaşılmalıdır.



710.100.103
45x45mm Yaylı Kapaklı
0,70 USD



710.100.104
22,5x45mm Yaylı Kapaklı
0,50 USD



710.100.105
45x45mm Yaylı Kapaklı - Çiftli
1 USD



Telefon -Data Konnektörleri



715.100.030
CAT3 TELEFON
1,00 USD



715.100.050
CAT5E DATA
1,30 USD



715.100.060
CAT6 DATA
1,40 USD



715.100.060AMP
CAT6 DÖNER KİTLEME
2,30 USD



715.100.061AMP
CAT6A DATA
1,40 USD

Dişi - Dişi Telefon - Data Konnektörleri



715.200.030
CAT3 TELEFON
3,30 USD



715.200.050
CAT5E DATA
3,60 USD



715.200.060
CAT6 DATA
3,60 USD



715.200.061
CAT6A DATA
5,80 USD

Telefon Data Fişleri



710.100.350
CAT5 DATA Fişi
0,10 USD



710.100.360
CAT6 DATA Fişi
0,20 USD



710.100.332 - 2 PIN
TELEFON Fişi
0,08 USD



710.100.334 - 4 PIN
TELEFON Fişi
0,08 USD



710.100.336 - 6PIN
TELEFON Fişi
0,08 USD



708.100.010
50x50mm - Tekli
15,00 TL



708.100.020
50x50mm - Çiftli
15,00 TL



709.100.103
45x45mm
17,00 TL



709.100.104
22.5x45mm
15,00 TL



Kanal Üstü Telefon - Data Kapakları



710.100.107
45x45mm Kapaksız - Çiftli
50,00 TL



710.100.111
22.5x45mm Kapaksız - Tekli
50,00 TL



710.100.106
45x45mm Kapaksız- Tekli
44,00 TL



709.200.104
22x45mm
15,00 TL



709.200.103
45x45mm
17,00 TL



45x45mm Kanal Üstü Keystone Kapakları



710.100.108
Yükseltme Kapağı
23,00 TL



710.100.109
Keystone - Faceplate - Tekli
41,00 TL



710.100.110
Keystone - Faceplate - Çiftli
45,00 TL

Fiberoptik Keystone



715.800.001
Fiber optik Keystone
216,00 TL



715.800.002
Fiber optik Keystone
216,00 TL



715.800.003
Fiber optik Keystone
216,00 TL

45x45mm Tv Prizler



723.000.150
TV Prizi
196,00 TL



723.000.300
TV Prizi Erkek 9.52mm
196,00 TL



723.000.400
TV Uydu Prizi
214,00 TL

VGA Konnektörleri



715.300.001
6+2 Klemens Girişli
22.5x45mm - Faceplate
240,00 TL



715.300.002
14+2 Klemens Girişli 22.5x45mm
Hızlı Montaj - Faceplate
288,00 TL



715.300.003
Soket Girişli
45x45mm - Faceplate
216,00 TL



715.300.004
Soket Girişli
22.5x45mm - Faceplate
144,00 TL



715.300.005
15 Klemens Girişli
22.5x45mm - Faceplate
240,00 TL



715.300.007
9 Pinli
22.5x45mm Faceplate
240,00 TL



715.300.009
B Soket Girişli
45x45mm - Faceplate
288,00 TL

RCA & STEREO Konnektörleri



715.500.002
RCA Konnektör 22.5x45mm
Klemensli - Faceplate
168,00 TL



715.500.001
RCA Konnektör 22.5x45mm
Klemensli - Faceplate
168,00 TL



715.600.001
Stereo Konnektör 22.5x45mm
Klemensli - Faceplate
96,00 TL

HDMI Konnektörleri



715.400.001
TİP A Dişi - Dişi 90°
22.5x45mm - Faceplate
240,00 TL



715.400.002
TİP A Dişi - Dişi 180°
22.5x45mm - Faceplate
240,00 TL



715.400.003
TİP A Dişi - Dişi Üstten
Giriş-Çıkışlı
22.5x45mm - Faceplate
240,00 TL

HDMI Konnektör



715.400.008
HDMI Konnektör TİP A Dişi-Dişi
45x45mm - Faceplate
480,00 TL

DISPLAY Konnektör



715.700.001
Display Port Konnektör Soket Girişli
45x45mm - Faceplate
480,00 TL

XLR Konnektör



715.600.002
XLR Dişi Soket
45x45mm Klemensli - Faceplate
240,00 TL

USB Konnektörleri



715.200.004
Standart A
USB AF/AF 90°
22.5x45mm - Faceplate
96,00 TL



715.200.005
Standart A
USB AF/AF 180°
22.5x45mm - Faceplate
96,00 TL



715.200.006
Standart A
Klemensli
22.5x45mm - Faceplate
96,00 TL

USB / HDMI Keystone



715.200.001
Standart B
Dişi - Dişi - Keystone
120,00 TL



715.200.002
Standart A
Dişi - Dişi - Keystone
120,00 TL



715.200.003
Standart A
Dişi - Dişi Kablolu - Keystone
324,00 TL



715.400.004
TİP A Dişi - Dişi
Keystone
168,00 TL



715.400.005
TİP A Dişi - Dişi
Kablolu Keystone
432,00 TL

Teknik Özellikler

Akım Değeri : 16A
Voltaj Değeri : 125/250 V AC
Koruma Derecesi : IP40

723.225.016
90,00 TL



Reset Butonlu
22.5x45mm

723.225.116
90,00 TL



Reset Anahtarlı
22.5x45mm

TEM | On - Off Anahtarlar



722.045.012
Tekli Anahtar 16A
45x45mm
Işsız
95,00 TL

722.045.112
Tekli Anahtar 16A
45x45mm
Işıklı
100,00 TL



722.045.011
Çiftli Anahtar
2x10A 45x45mm
Işsız
141,00 TL

722.045.111
Çiftli Anahtar
2x10A 45x45mm
Işıklı
146,00 TL



722.225.010
Anahtar 10A
22.5x45mm
Işsız
76,00 TL

722.225.110
Anahtar 10A
22.5x45mm
Işıklı
81,00 TL



722.225.021
Anahtar 16A
22.5x45mm
Işsız
95,00 TL



722.045.022
Çift Anahtar 2x16A
45x45mm
Işsız
135,00 TL



722.225.112
Anahtar 16A
22.5x45mm
Işıklı
108,00 TL



722.045.122
Çift Anahtar 2x16A
45x45mm
Işıklı
162,00 TL



- Wifi & Bluetooth Bağlantısı
- Tuya ve Smartlife Uygulamaları ile bağlantı (IOS / Android)
- Güvenlik: Bebek-Çocuk Koruması
- Sesli Kontrol:
Amazon Alexa / Google Home
- Zamanlayıcı ayarlanabilir.
- Cihaz Paylaşımı
- Güç tüketimi (V, A, kW/h)



works with the
Google Assistant



14017.1010.0202.1
2 Şebeke Prizi + 2 Prizli
Wifi Kontrol
1.843,00 TL



14017.1030.0202.1
3 Şebeke Prizi + USB Şarj
+ Wifi Kontrol
1.769,00 TL



14017.1040.0000.1
4 Şebeke Prizi +
Wifi Kontrol
1.803,00 TL

TEM 1U PDU

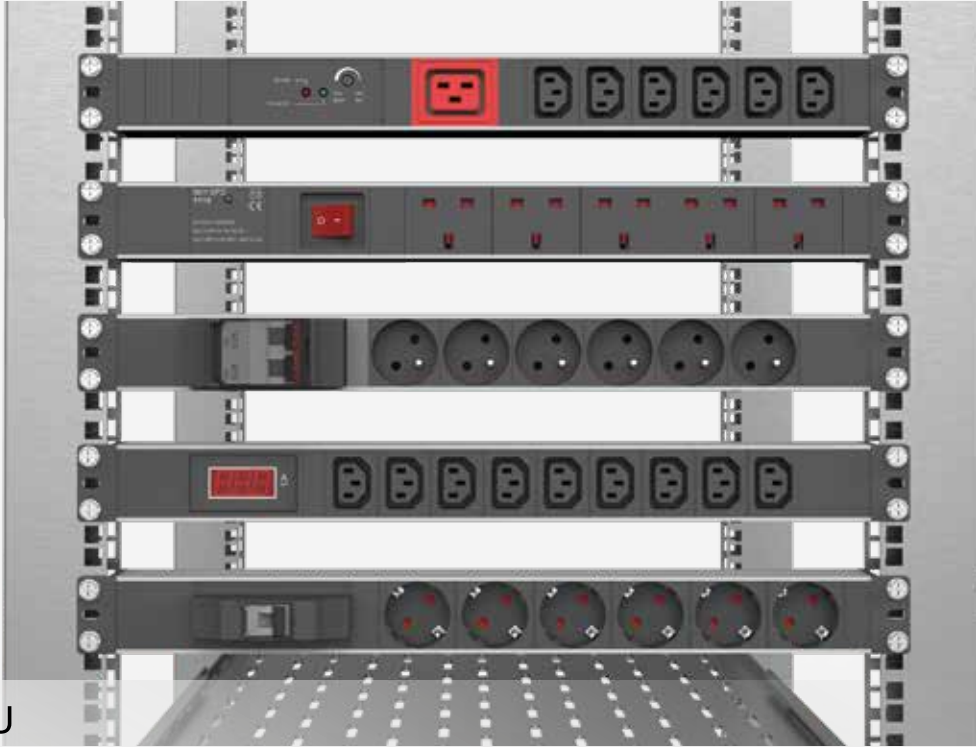

Standart



Ürün Kodu

- 14000.1070.000
- 14000.1080.000
- 19 14000.1090.000
- 14000.2070.000
- 14000.2080.000
- 19 14000.2090.000

Açıklama

- 7 Şebeke
- 8 Şebeke
- 9 Şebeke
- 7 UPS
- 8 UPS
- 9 UPS

Fiyat

- 700,00 TL
- 780,00 TL
- 860,00 TL
- 770,00 TL
- 860,00 TL
- 950,00 TL

Gerilim Korumalı



Ürün Kodu

- 14004.1060.000
- 19 14004.1070.000
- 14004.1080.000
- 14004.2060.000
- 19 14004.2070.000
- 14004.2080.000

Açıklama

- 6 Şebeke + Gerilim Koruma
- 7 Şebeke + Gerilim Koruma
- 8 Şebeke + Gerilim Koruma
- 6 UPS + Gerilim Koruma
- 7 UPS + Gerilim Koruma
- 8 UPS + Gerilim Koruma

Fiyat

- 1.200,00 TL
- 1.280,00 TL
- 1.360,00 TL
- 1.260,00 TL
- 1.350,00 TL
- 1.440,00 TL

Anahtarlı



Ürün Kodu

- 14003.1060.000
- 14003.1070.000
- 19 14003.1080.000
- 14003.2060.000
- 14003.2070.000
- 19 14003.2080.000

Açıklama

- 6 Şebeke + Anahtar
- 7 Şebeke + Anahtar
- 8 Şebeke + Anahtar
- 6 UPS + Anahtar
- 7 UPS + Anahtar
- 8 UPS + Anahtar

Fiyat

- 738,00 TL
- 818,00 TL
- 898,00 TL
- 798,00 TL
- 888,00 TL
- 978,00 TL

Tek Sigortalı



Ürün Kodu

- 14001.1040.000
- 19 14001.1060.000
- 14001.1080.000
- 14001.2040.000
- 19 14001.2060.000
- 14001.2080.000

Açıklama

- 4 Şebeke + Tekli Sigorta
- 6 Şebeke + Tekli Sigorta
- 8 Şebeke + Tekli Sigorta
- 4 UPS + Tekli Sigorta
- 6 UPS + Tekli Sigorta
- 8 UPS + Tekli Sigorta

Fiyat

- 824,00 TL**
- 984,00 TL**
- 1.144,00 TL**
- 864,00 TL**
- 1.044,00 TL**
- 1.224,00 TL**

Çift Sigortalı



Ürün Kodu

- 14002.1040.000
- 19 14002.1060.000
- 14002.1080.000
- 14002.2040.000
- 19 14002.2060.000
- 14002.2080.000

Açıklama

- 4 Şebeke + Çift Sigortalı
- 6 Şebeke + Çift Sigortalı
- 8 Şebeke + Çift Sigortalı
- 4 UPS + Çift Sigortalı
- 6 UPS + Çift Sigortalı
- 8 UPS + Çift Sigortalı

Fiyat

- 1.276,00 TL**
- 1.436,00 TL**
- 1.596,00 TL**
- 1.316,00 TL**
- 1.496,00 TL**
- 1.676,00 TL**

Butonlu Akım Korumalı



Ürün Kodu

- 14012.1060.000
- 14012.1070.000
- 19 14012.1080.000
- 14012.2060.000
- 14012.2070.000
- 19 14012.2080.000

Açıklama

- 6 Şebeke + Akım Koruma
- 7 Şebeke + Akım Koruma
- 8 Şebeke + Akım Koruma
- 6 UPS + Akım Koruma
- 7 UPS + Akım Koruma
- 8 UPS + Akım Koruma

Fiyat

- 826,00 TL**
- 906,00 TL**
- 986,00 TL**
- 886,00 TL**
- 976,00 TL**
- 1.066,00 TL**

Anahtarlı Akım Korumalı



Ürün Kodu

- 14013.1060.000
- 14013.1070.000
- 19 14013.1080.000
- 14013.2060.000
- 14013.2070.000
- 19 14013.2080.000

Açıklama

- 6 Şebeke + Anahtarlı Akım Koruma
- 7 Şebeke + Anahtarlı Akım Koruma
- 8 Şebeke + Anahtarlı Akım Koruma
- 6 UPS + Anahtarlı Akım Koruma
- 7 UPS + Anahtarlı Akım Koruma
- 8 UPS + Anahtarlı Akım Koruma

Fiyat

- 843,00 TL**
- 923,00 TL**
- 1.003,00 TL**
- 903,00 TL**
- 993,00 TL**
- 1.083,00 TL**

1U Kapak Modelleri



TEM 1U GST PDU



14002.0000.003
Çift Sigorta Modülü
1.395,00 TL



14014.0000.003
SPD + EMI-RFI Filtre Modülü
2.955,00 TL



14015.0000.003
SPD + Anahtar Modülü
1.257,00 TL



14000.1020.0202.3
2'li USB Şarj + 2 Şebeke
1.580,00 TL



14000.1040.003
4 Şebeke
955,00 TL



14003.1030.003
3 Şebeke + Anahtar
958,00 TL



725.3150.893
GST (Dişi + Erkek)
3x1,5 H05VV-F 3m
565,00 TL



725.3150.913
3m GST Dişi + UPS
3x1,5 H05VV-F 3m
475,00 TL



725.3150.933
3m GST Dişi + C14
3x1,5 H05VV-F 3m
665,00 TL



TEM U62 PDU

Boş Alüminyum Gövde



Ürün Kodu

Modül Sayısı (22,5mm)

Fiyat

16200.0010.000	8 + 2 x 22.5	405,00 TL
16200.0012.000	10 + 2 x 22.5	462,00 TL
16200.0014.000	12 + 2 x 22.5	520,00 TL
16200.0016.000	14 + 2 x 22.5	578,00 TL
16200.0018.000	16 + 2 x 22.5	645,00 TL
16200.0020.000	18 + 2 x 22.5	703,00 TL

Örnek Ürünler



16200.1232.8711.0
3 Şebeke + 2 UPS + 1 Cat6 + 1 Cat3
1.300,00 TL



16200.1222.8722.0
2 Şebeke + 2 UPS + 2 Cat6 + 2 Cat3
1.521,00 TL



16200.1222.872111.0
2 Şebeke + 2 UPS + 1 Cat6 + 1 Cat 3
+ 2'li USB Şarj
1.858,00 TL



16200.1223.8721.0
2 Şebeke + 3 UPS + 2 Cat6 + 1 Cat3
1.502,00 TL



16200.1233.8711.0
3 Şebeke + 3 UPS + 1 Cat6 + 1 Cat3
1.425,00 TL



16200.1030.153111.0
3 Şebeke + 1 VGA + 1 HDMI + 1 USB Şarj
1.877,00 TL



TEM U42 PDU

Standart



Ürün Kodu

- 14200.1070.000
- 19 14200.1080.000
- 14200.1090.000
- 14200.2070.000
- 19 14200.2080.000
- 14200.2090.000

Açıklama

- 7 Şebeke
- 8 Şebeke
- 9 Şebeke
- 7 UPS
- 8 UPS
- 9 UPS

Fiyat

- 1.175,00 TL
- 1.271,00 TL
- 1.367,00 TL
- 1.232,00 TL
- 1.348,00 TL
- 1.463,00 TL

Tek Sigortalı



Ürün Kodu

- 14201.1040.000
- 19 14201.1060.000
- 14201.1080.000
- 14201.2040.000
- 19 14201.2060.000
- 14201.2080.000

Açıklama

- 4 Şebeke + Tekli Sigorta
- 6 Şebeke + Tekli Sigorta
- 8 Şebeke + Tekli Sigorta
- 4 UPS + Tekli Sigorta
- 6 UPS + Tekli Sigorta
- 8 UPS + Tekli Sigorta

Fiyat

- 1.117,00 TL
- 1.329,00 TL
- 1.540,00 TL
- 1.115,00 TL
- 1.386,00 TL
- 1.167,00 TL

Anahtarlı



Ürün Kodu

- 14203.1060.000
- 19 14203.1070.000
- 14203.1080.000
- 14203.2060.000
- 19 14203.2070.000
- 14203.2080.000

Açıklama

- 6 Şebeke + Anahtar
- 7 Şebeke + Anahtar
- 8 Şebeke + Anahtar
- 6 UPS + Anahtar
- 7 UPS + Anahtar
- 8 UPS + Anahtar

Fiyat

- 1.040,00 TL
- 1.155,00 TL
- 1.271,00 TL
- 1.098,00 TL
- 1.223,00 TL
- 1.348,00 TL



14200.1223.8721.0
2 Şebeke + 3 UPS + 2 Cat6 + 1 Cat3
1.444,00 TL



14200.1233.8711.0
3 Şebeke + 3 UPS + 1 Cat6 + 1 Cat3
1.358,00 TL



14200.1232.8711.0
3 Şebeke + 2 UPS + 1 Cat6 + 1 Cat3
1.232,00 TL



14200.1222.8722.0
2 Şebeke + 2 UPS + 2 Cat6 + 2 Cat3
1.454,00 TL



14202.1050.000
5 Şebeke + Çift Sigortalı
1.348,00 TL



14200.1040.110
4 Şebeke + 2'li USB Şarj
1.271,00 TL



14300.1223.8721.0
2 Şebeke + 3 UPS + 2 Cat6 + 1 Cat3
1.617,00 TL



14300.1222.8722.0
2 Şebeke + 2 UPS + 2 Cat6 + 2 Cat3
1.598,00 TL



14300.1232.8711.0
3 Şebeke + 2 UPS + 1 Cat6 + 1 Cat3
1.454,00 TL

TEM G70 Masaüstü PDU

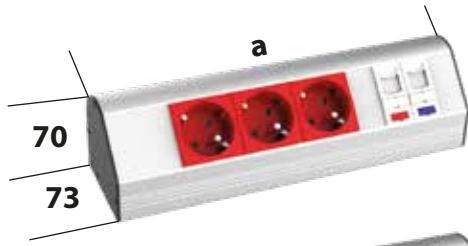

Ürün Kodu	Açıklama	^a (mm)	Fiyat
17000.2030.8711.0	3 UPS + 1 Cat6 + 1 Cat3	280	1.059,00 TL
17000.1222.8711.0	2 Şebeke + 2 UPS + 1 Cat6 + 1 Cat3	348	1.242,00 TL
17000.2631.8711.0	3 UPS + 1 Üniversal Priz + 1 Cat6 + 1 Cat3	347,5	1.329,00 TL
17000.2030.187111.0	3 UPS + 1 Cat6 + 1 Cat3 + 1 USB Şarj	302,5	1.300,00 TL

* a = yan kapaklar dahil toplam ürün ölçüsü

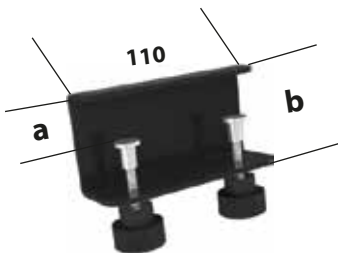

Ürün Kodu	Açıklama	^a (mm)	^b (mm)	Fiyat
740.050.030	Küçük Boy	18 ≤ a ≤ 35	56	385,00 TL
740.050.070	Büyük Boy	35 ≤ a ≤ 75	96	559,00 TL

* a = Masa kalınlığı ölçüsü

H100 Tavan Baęlantı Aparatı



H100 Kolon Ayaęı

Kolon Kanal Modelleri

U62

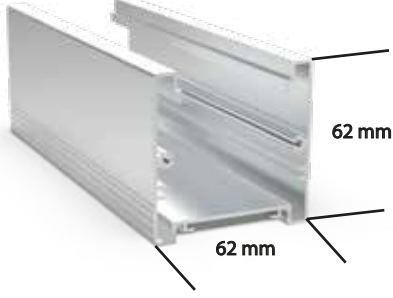

U62 Çiftli



H100

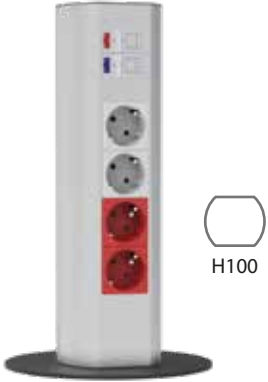

11400.1244.8722.0
4 Şebeke + 4 UPS +
2 Cat6 + 2 Cat3
2.118,00 TL



11400.1040.8142.0
4 Şebeke + 2x2'li USB Şarj
+ 4 Cat6
3.234,00 TL



11400.1020.135222.0
2 Şebeke + 2 USB Şarj +
2 VGA + 2 HDMI
3.350,00 TL



11400.1040.120
4 Şebeke
2x2'li USB Şarj
2.503,00 TL



11000.1244.136222.0
4 Şebeke + 4 UPS + 2 USB Şarj
+ 2 HDMI + 2 RCA
3.812,00 TL

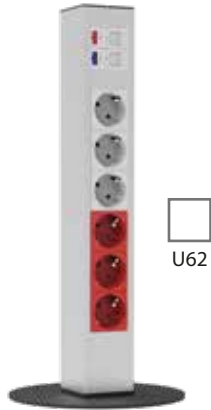

11100.1233.8711.0
3 Şebeke + 3 UPS +
1 Cat 6 + 1 Cat 3
1.569,00 TL



1110.1222.8200.0
2 Şebeke + 2 UPS
2 Cat6
1.450,00 TL

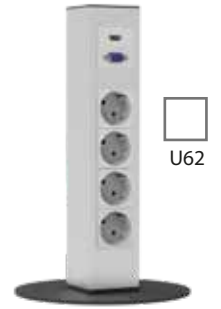

1110.1040.3511.0
4 Şebeke + 1 HDMI
+ 1 VGA
1.829,00 TL



Boş Alüminyum Gövde

Ürün Kodu

Kesim Ölçüsü

a
(mm)

Fiyat

17100.0010.000

232x105

225

501,00 TL

17100.0012.000

277x105

270

568,00 TL

17100.0014.000

322x105

315

636,00 TL

17100.0016.000

367x105

360

703,00 TL

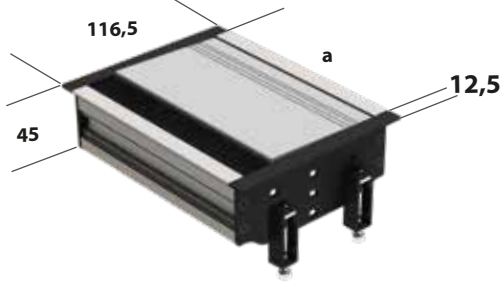

* a = yan kapaklar hariç net alüminyum ölçüsü
a+25 = Toplam ürün ölçüsü

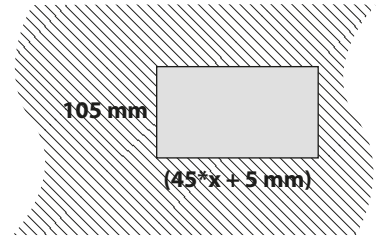

1750.1030.1211.1
3 Şebeke Prizi + Tip A/C USB Şarj

3.750,00 TL

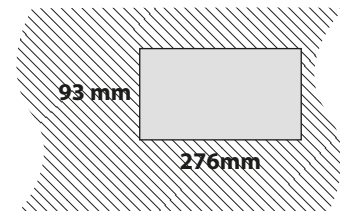



TEM 044 PDU

	Ürün Kodu	Açıklama	a (mm)	Fiyat
	11800.1020.210	2 Şebeke + 2'li USB Şarj	232	1.736,00 TL
	11800.2020.210	2 UPS + 2'li USB Şarj	232	1.753,00 TL
	11800.1030.000	3 Şebeke	205	1.052,00 TL
	11800.2030.000	3 UPS	205	1.076,00 TL
	11804.1020.210	2 Şebeke + 2'li USB Şarj + Gerilim Koruma	307	2.106,00 TL
	11804.2020.210	2 UPS + 2'li USB Şarj + Gerilim Koruma	307	2.124,00 TL
	11804.1030.000	3 Şebeke + Gerilim Koruma	280	1.395,00 TL
	11804.2030.000	3 UPS + Gerilim Koruma	280	1.420,00 TL



Kesim Ölçüsü
(Ø)60mm

Masa Kalınlığı
0 - 50mm

- Kullanılmadıkça yer kaplamayan grup priz
- Özel kilit mekanizması



Modüler Tekli Şarj Kutusu

● Masa Kesim Ölçüsü: Ø60mm



1470.1010.1010.1
Şebeke Prizi + Tip A USB Şarj
1.750,00 TL



1470.5010.1010.1
UPS Prizi + Tip A USB Şarj
1.850,00 TL



1470.4010.1010.1
İngiliz Prizi + Tip A USB Şarj
2.100,00 TL

Modüler Tekli Şarj Kutusu Kablosuz Şarj Kapaklı

● Masa Kesim Ölçüsü: Ø80mm

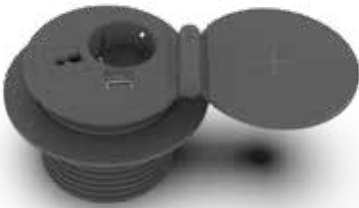

1460.1010.1211.1
Şebeke Prizi + 1Ad. Tip A/C USB Şarj
+ Kablosuz Şarj + Kablo Geçiş Yuvası
3.000,00 TL

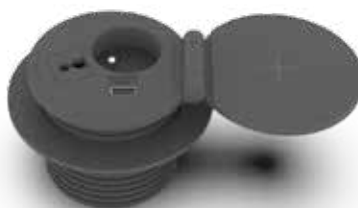

1460.5010.1211.1
UPS Prizi + Tip A/C USB Şarj
+ Kablosuz Şarj + Kablo Geçiş Yuvası
3.100,00 TL

Pop-up

● Masa Kesim Ölçüsü: Ø120mm



1450.1040.1222.1
4lü Şebeke Prizi Kablosuz Şarj
+ 2 Ad. Tip A/C USB Şarj
6.250,00 TL



1450.5040.1222.1
4lü Fransız Prizi + Kablosuz Şarj
+ 2 Ad. Tip A/C USB Şarj
6.500,00 TL



TEM Güç Çerçevesi

Boş Alüminyum Gövde

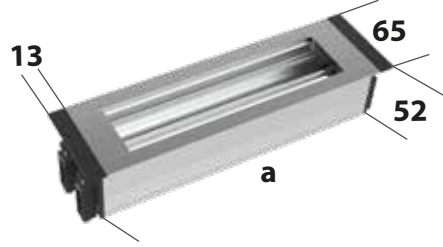

Ürün Kodu	Modül Sayısı (22,5)	Kesim Ölçüsü a+7(mm)	a (mm)	Fiyat
17200.0010.000	8 + 2 x 22.5	232 x 55	225	434,00 TL
17200.0012.000	10 + 2 x 22.5	277 x 55	270	491,00 TL
17200.0014.000	12 + 2 x 22.5	322 x 55	315	549,00 TL
17200.0016.000	14 + 2 x 22.5	367 x 55	360	607,00 TL

* a = yan kapaklar hariç net alüminyum ölçüsü
a+26 = Toplam ürün ölçüsü

Ürün Kodu	Açıklama	Kesim Ölçüsü a+6(mm)	a (mm)	Fiyat
-----------	----------	-------------------------	-----------	-------



17200.1020.110	2 Şebeke + USB Şarj	208,5 x 55	202,5	1.175,00 TL
17200.2030.8711.0	3 UPS + 1 Cat6 + 1 Cat3	276 x 55	270	1.059,00 TL
17200.4020.1511.0	2 İngiliz Prizi + 1 USB Şarj + VGA	243 x 55	225	1.656,00 TL
17200.1222.820.0	2 Şebeke + 2 UPS + 2 Cat6	343,5 x 55	337,5	1.232,00 TL

TEM Kapaklı Güç Çerçevesi



Boş Alüminyum Gövde	Ürün Kodu	Modül Sayısı (22,5)	Kesim Ölçüsü a+35(mm)	a (mm)	Fiyat
	17300.0010.0	8 + 2 x 22.5	260x105	225	876,00 TL
	17300.0012.0	10 + 2 x 22.5	305x105	270	1.001,00 TL
	17300.0014.0	12 + 2 x 22.5	350x105	315	1.127,00 TL
	17300.0016.0	14 + 2 x 22.5	395x105	360	1.252,00 TL

* a = yan kapaklar hariç net alüminyum ölçüsü
a+56 = Toplam ürün ölçüsü

Örnek Ürünler	Ürün Kodu	Açıklama	Kesim Ölçüsü a+35(mm)	a (mm)	Fiyat
	17300.1020.110	2 Şebeke + 1 USB Şarj	237,5 x 105	202,5	1.675,00 TL
	17300.1020.8711.0	2 Şebeke + 1 Cat6 + 1 Cat3	260 x 105	225	1.444,00 TL
	17300.1222.8711.0	2 Şebeke + 2 UPS + 1 Cat6 + 1 Cat3	372,5 x 105	337,5	1.906,00 TL
	17300.1631.210	3 Şebeke + 1 Üniversal Priz +2'li USB Şarj	395 x 105	360	2.946,00 TL



TEM Yatay Masa Grubu

Boş Alüminyum Gövde	Ürün Kodu	Modül Sayısı (22,5mm)	Kesim Ölçüsü a+70(mm)	a (mm)	Fiyat
	17400.0010.000	8 + 2 x 22.5 Modül	295 x 135	225	1.329,00 TL
	17400.0012.000	10 + 2 x 22.5 Modül	340 x 135	270	1.425,00 TL
	17400.0014.000	12 + 2 x 22.5 Modül	385 x 135	315	1.521,00 TL
	17400.0016.000	14 + 2 x 22.5 Modül	430 x 135	360	1.617,00 TL

* **a** = Boş kanal içi kullanılabilirlik ölçüsü
a+70 = Ürün kesim ölçüsü
a+100 = Toplam ürün ölçüsü

Örnek Ürünler	Ürün Kodu	Açıklama	Kesim Ölçüsü a+70(mm)	a (mm)	Fiyat
	17400.1040.820	4 Şebeke + 2 Cat6	362,5x135	292,5	2.176,00 TL
	17400.1222.8711.0	2 Şebeke + 2 UPS + 1 Cat6 +1 Cat3	385x135	315	2.118,00 TL
	17400.1224.842	2 Şebeke + 4 UPS + 4 Cat6 + Soket Girişli	520x135	450	3.003,00 TL
	17400.1233.840	3 Şebeke + 3 UPS + 4 Cat6	520x135	450	2.984,00 TL

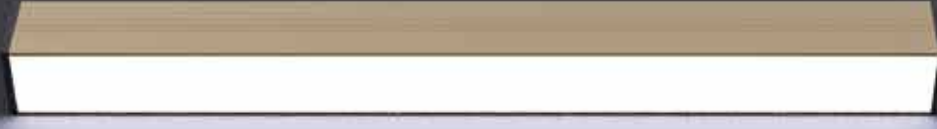

Kontrol Seçenekleri

- PIR Hareket Sensörü
- IR Yaklaşım Kapı Sensörü
- IR Yaklaşım Aç Kapa
- Dokunmatik Aç Kapa
- Dokunmatik 3 Kademeli Dimmer
- On / Off Anahtar

TEM Aydınlatma

- Giriş: 220 V Sürücülü
220 V Sürücüsüz
24 V Sürücüsüz
- Montaj: Askılı
Vidalı
Mıknatıslı



Standart

	Ürün Kodu	Açıklama	Mıknatıssız Fiyat	Mıknatıslı Fiyat
220 V Sürücülü	14005.20.3508.X1	35cm 8,4W 1m Kablolu	1.081,00 TL	1.398,00 TL
	14005.20.5514.X1	55cm 14W 1m Kablolu	1.253,00 TL	1.570,00 TL
24 V Sürücüsüz	14005.40.3508.X1	35cm 8,4W 1m Kablolu	683,00 TL	1.000,00 TL
	14005.40.5514.X1	55cm 14W 1m Kablolu	855,00 TL	1.172,00 TL

X = 0 Mıknatıssız
X = 1 Mıknatıslı

On - Off Anahtarlı



	Ürün Kodu	Açıklama	Mıknatıssız Fiyat	Mıknatıslı Fiyat
220 V Sürücülü	14005.21.3508.X1	35cm 8,4W 1m Kablolu	1.135,00 TL	1.452,00 TL
	14005.21.5514.X1	55cm 14W 1m Kablolu	1.307,00 TL	1.624,00 TL
24 V Sürücüsüz	14005.41.3508.X1	35cm 8,4W 1m Kablolu	737,00 TL	1.054,00 TL
	14005.41.5514.X1	55cm 14W 1m Kablolu	909,00 TL	1.226,00 TL

X = 0 Mıknatıssız
X = 1 Mıknatıslı

Dokunmatik Aç - Kapa



	Ürün Kodu	Açıklama	Mıknatıssız Fiyat	Mıknatıslı Fiyat
220 V Sürücülü	14005.22.3508.X1	35cm 8,4W 1m Kablolu	1.415,00 TL	1.732,00 TL
	14005.22.5514.X1	55cm 14W 1m Kablolu	1.587,00 TL	1.904,00 TL
24 V Sürücüsüz	14005.42.3508.X1	35cm 8,4W 1m Kablolu	1.018,00 TL	1.334,00 TL
	14005.42.5514.X1	55cm 14W 1m Kablolu	1.190,00 TL	1.506,00 TL

X = 0 Mıknatıssız
X = 1 Mıknatıslı

PIR Hareket Sensörü



	Ürün Kodu	Açıklama	Mıknatıssız Fiyat	Mıknatıslı Fiyat
220 V Sürücülü	14005.23.3508.X1	35cm 8,4W 1m Kablolu	1.910,00 TL	2.227,00 TL
	14005.23.5514.X1	55cm 14W 1m Kablolu	2.082,00 TL	2.399,00 TL
24 V Sürücüsüz	14005.43.3508.X1	35cm 8,4W 1m Kablolu	1.513,00 TL	1.829,00 TL
	14005.43.5514.X1	55cm 14W 1m Kablolu	1.685,00 TL	2.001,00 TL

X = 0 Mıknatıssız
X = 1 Mıknatıslı



Yaklaşım Kapı Sensörü

	Ürün Kodu	Açıklama	Mıknatıssız Fiyat	Mıknatıslı Fiyat
220 V Sürücülü	14005.24.3508.X1	35cm 8,4W 1m Kablolu	1.185,00 TL	2.202,00 TL
	14005.24.5514.X1	55cm 14W 1m Kablolu	2.057,00 TL	2.374,00 TL
24 V Sürücüsüz	14005.44.3508.X1	35cm 8,4W 1m Kablolu	1.488,00 TL	1.805,00 TL
	14005.44.5514.X1	55cm 14W 1m Kablolu	1.660,00 TL	1.977,00 TL

X = 0 Mıknatıssız
X = 1 Mıknatıslı



3 Kademeli Dimmer

	Ürün Kodu	Açıklama	Mıknatıssız Fiyat	Mıknatıslı Fiyat
220 V Sürücülü	14005.25.3508.X1	35cm 8,4W 1m Kablolu	1.415,00 TL	1732,00 TL
	14005.25.5514.X1	55cm 14W 1m Kablolu	1.587,00 TL	1.904,00 TL
24 V Sürücüsüz	14005.45.3508.X1	35cm 8,4W 1m Kablolu	1.018,00 TL	1.334,00 TL
	14005.45.5514.X1	55cm 14W 1m Kablolu	1.190,00 TL	1.506,00 TL

X = 0 Mıknatıssız
X = 1 Mıknatıslı



IR Yaklaşım Aç - Kapa

	Ürün Kodu	Açıklama	Mıknatıssız Fiyat	Mıknatıslı Fiyat
220 V Sürücülü	14005.26.3508.X1	35cm 8,4W 1m Kablolu	1.885,00 TL	2.202,00 TL
	14005.26.5514.X1	55cm 14W 1m Kablolu	2.057,00 TL	2.374,00 TL
24 V Sürücüsüz	14005.46.3508.X1	35cm 8,4W 1m Kablolu	1.488,00 TL	1.805,00 TL
	14005.46.5514.X1	55cm 14W 1m Kablolu	1.660,00 TL	1.977,00 TL

X = 0 Mıknatıssız
X = 1 Mıknatıslı



U20 Aydınlatma

	Ürün Kodu	Açıklama	Mıknatıssız Fiyat	Mıknatıslı Fiyat
220 V	1200.27.3505.X1	220V 1m Kablolu + 35cm 5W	925,00 TL	956,00 TL
	1200.27.4106.X1	220V 1m Kablolu + 41cm 6W	974,00 TL	1.011,00 TL
	1200.27.5210.X1	220V 1m Kablolu + 52cm 10W	1.096,00 TL	1.142,00 TL
24V	1200.28.2004.X1	24V 1m Kablolu + 20cm 4.3W	943,00 TL	961,00 TL
	1200.28.3004.X1	24V 1m Kablolu + 30cm 4.3W	1.050,00 TL	1.077,00 TL
	1200.29.5007.X1	24V 1m Kablolu + 50cm 7.2W	1.377,00 TL	1.422,00 TL
	1200.29.10014.X1	24V 1m Kablolu + 100cm 14.1W	2.195,00 TL	2.285,00 TL

X = 0 Mıknatıssız
X = 1 Mıknatıslı



TEM Linear Armatür

- Giriş: 220 V Sürüclü
24 V Sürücüsüz

- Montaj: Askılı
Vidalı
Mıknatıslı

Tip 1U

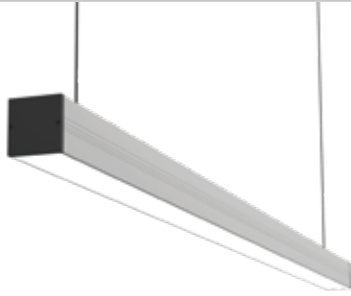

	Ürün Kodu	Açıklama	Fiyat
220 V Sürüclü	140025.20.6016	60cm 16,8W	1.605,00 TL
	140025.20.9025	90cm 25,2W	1.954,00 TL
	140025.20.12033	120cm 33,6W	2.368,00 TL
	140025.20.15042	150cm 42W	2.772,00 TL
24 V	140025.40.6016	60cm 16,8W	1.165,00 TL
	140025.40.9025	90cm 25,2W	1.579,00 TL
	140025.40.12033	120cm 33,6W	1.974,00 TL
	140025.40.15042	150cm 42W	2.407,00 TL

Tip C

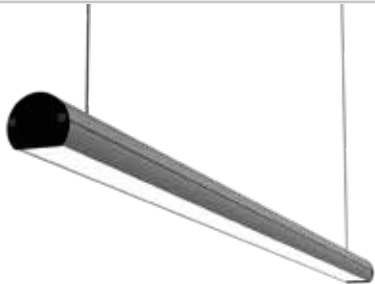

	Ürün Kodu	Açıklama	Fiyat
220 V Sürüclü	140425.20.6016	60cm 16,8W	1.618,00 TL
	140425.20.9025	90cm 25,2W	2.012,00 TL
	140425.20.12033	120cm 33,6W	2.445,00 TL
	140425.20.15042	150cm 42W	2.869,00 TL
24 V	140425.40.6016	60cm 16,8W	1.204,00 TL
	140425.40.9025	90cm 25,2W	1.637,00 TL
	140425.40.12033	120cm 33,6W	2.051,00 TL
	140425.40.15042	150cm 42W	2.503,00 TL

Yan Kapak Seçenekleri

Düz Yan Kapak
Vidalı Yan Kapak
Gst Soketli Yan Kapak

Opsiyonel Sinyal Led



Priz Seçenekleri

Şebeke
UPS
İngiliz
Fransız
IEC C13 / C19

Kontrol Seçenekleri

On / Off Anahtar
Sensör
Anahtar + Kumanda Kablosu

LED Seçenekleri

13 cm LED
30 cm LED
50 cm LED

TEM Prizli Aydınlatma

- Giriş: 220 V Sürücülü
24 V Sürücüsüz

- Montaj: Vidalı
Mıknatıslı

Tip 1U



220 V
Sürücülü

Ürün Kodu

14005.1013.1020.X0
14005.1013.2020.X0

Açıklama

2 Şebeke + 13cm LED
2 UPS + 13cm LED

Mıknatıssız Fiyat

890,00 TL
910,00 TL

Mıknatıslı Fiyat

1.190,00 TL
1.210,00 TL

220 V
Sürücülü

14005.2030.1020.X0
14005.2030.2020.X0

2 Şebeke + 30cm LED
2 UPS + 30cm LED

1.379,00 TL
1.399,00 TL

1.679,00 TL
1.699,00 TL

X = 0 Mıknatıssız

X = 1 Mıknatıslı

Tip G70



220 V
Sürücülü

Ürün Kodu

17005.2030.1020.0
17005.2030.1040.0
17005.2050.1020.0
17005.2050.1040.0

Açıklama

2 Şebeke + 30cm LED
4 Şebeke + 30cm LED
2 Şebeke + 50cm LED
4 Şebeke + 50cm LED

Fiyat

1.516,00 TL
1.678,00 TL
1.889,00 TL
2.055,00 TL



Döşeme Altı Buat

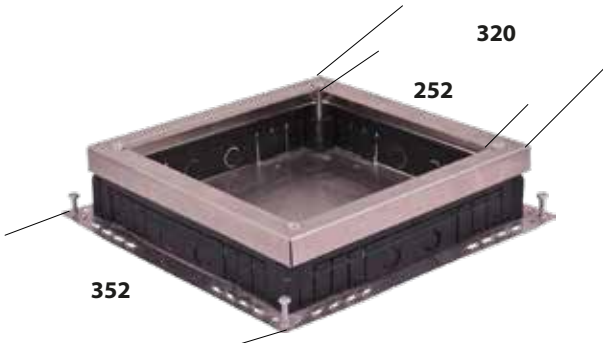

205.310.000

Döşeme Altı Buat

1.100,00 TL

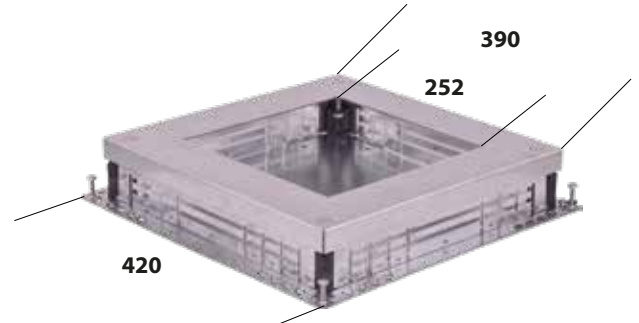

205.390.000

Döşeme Altı Buat

1.160,00 TL



Döşme Altı Priz Kutuları

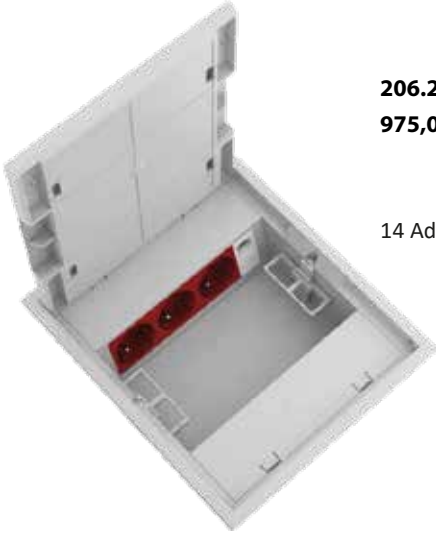

206.252.014

975,00 TL

14 Adet 22.5 Modül

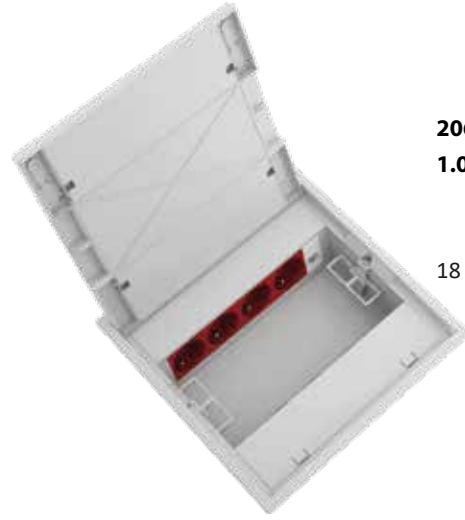

206.252.018

1.050,00 TL

18 Adet 22.5 Modül



206.252.024

1.125,00 TL

24 Adet 22.5 Modül

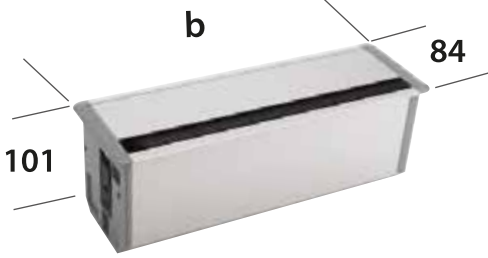

Ürün Kodu	Modül	b	Eloksal	Beyaz / Siyah
810.020.01X	2x45	132	1.143,00 TL	1.416,00 TL
810.030.01X	3x45	171	1.389,00 TL	1.672,00 TL
810.040.01X	4x45	238	1.661,00 TL	1.956,00 TL
810.050.01X	5x45	279	1.884,00 TL	2.217,00 TL
810.060.01X	6x45	342	2.102,00 TL	2.543,00 TL
810.070.01X	7x45	387	2.266,00 TL	2.707,00 TL
810.080.01X	8x45	449	2.443,00 TL	2.930,00 TL
810.090.01X	9x45	474	2.601,00 TL	3.099,00 TL
810.0100.01X	10x45	534	2.730,00 TL	3.281,00 TL

X : 1 Eloksal X : 3 Siyah X : 6 Beyaz

Tüm ölçüler mm cinsindedir.

TEM | 113x210
Dahili Priz Kutuları



210.0000.0000
113x210x70mm
228,00 TL



210.1200.4400
4 Şebeke + 4 UPS
924,00 TL



212.1000.6000
6 Şebeke + 2'li Sigorta Yeri
656,00 TL



TEM | 210x280
Dahili Priz Kutuları



280.0000.0000
210x280x70mm
384,00 TL



280.1200.6600
6 Şebeke + 6 UPS
1.344,00 TL



282.1200.6300
6 Şebeke + 3 UPS + 2'li Sigorta Yeri
1.104,00 TL



Dik Pano Prizleri

IP44 50/60 Hz.



Ürün Kodu	Kutup	I(A)	h	Volt		Fiyat
444.316.280	2P+E	16	4	110-130	12	265,00 TL
446.316.280	2P+E	16	6	200-250	12	215,00 TL
446.332.280	2P+E	32	6	200-250	12	320,00 TL
446.416.280	3P+E	16	6	380-415	12	260,00 TL
446.432.280	3P+E	32	6	380-415	12	365,00 TL
446.516.280	3P+N+E	16	6	380-415	12	320,00 TL
446.532.280	3P+N+E	32	6	380-415	12	390,00 TL

Eğik Pano Prizleri

IP44 50/60 Hz.



Ürün Kodu	Kutup	I(A)	h	Volt		Fiyat
444.316.250	2P+E	16	4	110-130	12	265,00 TL
446.316.250	2P+E	16	6	200-250	12	215,00 TL
446.332.250	2P+E	32	6	200-250	12	320,00 TL
446.416.250	3P+E	16	6	380-415	12	260,00 TL
446.432.250	3P+E	32	6	380-415	12	365,00 TL
446.463.250	3P+E	63	6	380-415	6	975,00 TL
446.516.250	3P+N+E	16	6	380-415	12	320,00 TL
446.532.250	3P+N+E	32	6	380-415	12	390,00 TL
446.563.250	3P+N+E	63	6	380-415	6	1.250,00 TL

Uzatma Prizleri

IP44 50/60 Hz.



Ürün Kodu	Kutup	I(A)	h	Volt		Fiyat
444.316.200	2P+E	16	4	110-130	12	275,00 TL
446.316.200	2P+E	16	6	200-250	12	225,00 TL
446.332.200	2P+E	32	6	200-250	12	340,00 TL
446.416.200	3P+E	16	6	380-415	12	275,00 TL
446.432.200	3P+E	32	6	380-415	12	380,00 TL
446.463.200	3P+E	63	6	380-415	6	1.400,00 TL
446.516.200	3P+N+E	16	6	380-415	12	330,00 TL
446.532.200	3P+N+E	32	6	380-415	12	400,00 TL
446.563.200	3P+N+E	63	6	380-415	6	1.600,00 TL

Uzatma Fişleri

IP44 50/60 Hz.



Ürün Kodu	Kutup	I(A)	h	Volt		Fiyat
444.316.300	2P+E	16	4	110-130	12	205,00 TL
446.316.300	2P+E	16	6	200-250	12	175,00 TL
446.332.300	2P+E	32	6	200-250	12	275,00 TL
446.416.300	3P+E	16	6	380-415	12	205,00 TL
446.432.300	3P+E	32	6	380-415	12	285,00 TL
446.463.300	3P+E	63	6	380-415	6	950,00 TL
446.516.300	3P+N+E	16	6	380-415	12	250,00 TL
446.532.300	3P+N+E	32	6	380-415	12	300,00 TL
446.563.300	3P+N+E	63	6	380-415	6	1.150,00 TL

Dik Pano Prizleri

IP67 50/60 Hz.



Ürün Kodu	Kutup	I(A)	h	Volt		Fiyat
674.316.280	2P+E	16	4	110-130	12	395,00 TL
676.316.280	2P+E	16	6	200-250	12	345,00 TL
676.332.280	2P+E	32	6	200-250	12	450,00 TL
676.416.280	3P+E	16	6	380-415	12	390,00 TL
676.432.280	3P+E	32	6	380-415	12	495,00 TL
676.516.280	3P+N+E	16	6	380-415	12	450,00 TL
676.532.280	3P+N+E	32	6	380-415	12	520,00 TL

Eğik Pano Prizleri

IP67 50/60 Hz.



Ürün Kodu	Kutup	I(A)	h	Volt		Fiyat
674.316.250	2P+E	16	4	110-130	12	395,00 TL
676.316.250	2P+E	16	6	200-250	12	345,00 TL
676.332.250	2P+E	32	6	200-250	12	450,00 TL
676.416.250	3P+E	16	6	380-415	12	390,00 TL
676.432.250	3P+E	32	6	380-415	12	495,00 TL
676.463.250	3P+E	63	6	380-415	6	1.150,00 TL
676.516.250	3P+N+E	16	6	380-415	12	450,00 TL
676.532.250	3P+N+E	32	6	380-415	12	520,00 TL
676.563.250	3P+N+E	63	6	380-415	6	1.450,00 TL

Uzatma Prizleri

IP67 50/60 Hz.



Ürün Kodu	Kutup	I(A)	h	Volt		Fiyat
674.316.200	2P+E	16	4	110-130	12	405,00 TL
676.316.200	2P+E	16	6	200-250	12	355,00 TL
676.332.200	2P+E	32	6	200-250	12	490,00 TL
676.416.200	3P+E	16	6	380-415	12	405,00 TL
676.432.200	3P+E	32	6	380-415	12	530,00 TL
676.463.200	3P+E	63	6	380-415	6	1.450,00 TL
676.516.200	3P+N+E	16	6	380-415	12	480,00 TL
676.532.200	3P+N+E	32	6	380-415	12	550,00 TL
676.563.200	3P+N+E	63	6	380-415	6	1.700,00 TL

Uzatma Fişleri

IP67 50/60 Hz.



Ürün Kodu	Kutup	I(A)	h	Volt		Fiyat
674.316.300	2P+E	16	4	110-130	12	325,00 TL
676.316.300	2P+E	16	6	200-250	12	295,00 TL
676.332.300	2P+E	32	6	200-250	12	415,00 TL
676.416.300	3P+E	16	6	380-415	12	325,00 TL
676.432.300	3P+E	32	6	380-415	12	425,00 TL
676.463.300	3P+E	63	6	380-415	6	1.000,00 TL
676.516.300	3P+N+E	16	6	380-415	12	350,00 TL
676.532.300	3P+N+E	32	6	380-415	12	440,00 TL
676.563.300	3P+N+E	63	6	380-415	6	1.222,00 TL

Eğik Duvar Prizleri

IP44 50/60 Hz.



Ürün Kodu	Kutup	I(A)	h	Volt		Fiyat
444.316.282	2P+E	16	4	110-130	10	435,00 TL
446.316.282	2P+E	16	6	200-250	10	385,00 TL
446.332.282	2P+E	32	6	200-250	6	490,00 TL
446.416.282	3P+E	16	6	380-415	10	430,00 TL
446.432.282	3P+E	32	6	380-415	6	535,00 TL
446.516.282	3P+N+E	16	6	380-415	10	490,00 TL
446.532.282	3P+N+E	32	6	380-415	6	580,00 TL

Eğik Duvar Prizleri + Monofaze

IP44 50/60 Hz.



Ürün Kodu	Kutup	I(A)	h	Volt		Fiyat
444.316.283	2P+E	16	4	110-130	10	515,00 TL
446.316.283	2P+E	16	6	200-250	10	465,00 TL
446.332.283	2P+E	32	6	200-250	6	570,00 TL
446.416.283	3P+E	16	6	380-415	10	510,00 TL
446.432.283	3P+E	32	6	380-415	6	615,00 TL
446.516.283	3P+N+E	16	6	380-415	10	570,00 TL
446.532.283	3P+N+E	32	6	380-415	6	660,00 TL

Dik Duvar Prizleri

IP44 50/60 Hz.



Ürün Kodu	Kutup	I(A)	h	Volt		Fiyat
444.316.281	2P+E	16	4	110-130	10	385,00 TL
446.316.281	2P+E	16	6	200-250	10	335,00 TL
446.332.281	2P+E	32	6	200-250	6	440,00 TL
446.416.281	3P+E	16	6	380-415	10	380,00 TL
446.432.281	3P+E	32	6	380-415	6	485,00 TL
446.516.281	3P+N+E	16	6	380-415	10	440,00 TL
446.532.281	3P+N+E	32	6	380-415	6	500,00 TL

Eğik Duvar Prizleri

IP67 50/60 Hz.



Ürün Kodu	Kutup	I(A)	h	Volt		Fiyat
674.316.282	2P+E	16	4	110-130	10	575,00 TL
676.316.282	2P+E	16	6	200-250	10	525,00 TL
676.332.282	2P+E	32	6	200-250	6	630,00 TL
676.416.282	3P+E	16	6	380-415	10	570,00 TL
676.432.282	3P+E	32	6	380-415	6	675,00 TL
676.516.282	3P+N+E	16	6	380-415	10	630,00 TL
676.532.282	3P+N+E	32	6	380-415	6	720,00 TL

Eğik Duvar Prizleri + Monofaze

IP44 50/60 Hz.



Ürün Kodu	Kutup	I(A)	h	Volt		Fiyat
674.316.283	2P+E	16	4	110-130	10	655,00 TL
676.316.283	2P+E	16	6	200-250	10	605,00 TL
676.332.283	2P+E	32	6	200-250	6	710,00 TL
676.416.283	3P+E	16	6	380-415	10	650,00 TL
676.432.283	3P+E	32	6	380-415	6	755,00 TL
676.516.283	3P+N+E	16	6	380-415	10	710,00 TL
676.532.283	3P+N+E	32	6	380-415	6	800,00 TL

Dik Duvar Prizleri

IP67 50/60 Hz.



Ürün Kodu	Kutup	I(A)	h	Volt		Fiyat
674.316.281	2P+E	16	4	110-130	10	535,00 TL
676.316.281	2P+E	16	6	200-250	10	485,00 TL
676.332.281	2P+E	32	6	200-250	6	590,00 TL
676.416.281	3P+E	16	6	380-415	10	530,00 TL
676.432.281	3P+E	32	6	380-415	6	635,00 TL
676.516.281	3P+N+E	16	6	380-415	10	590,00 TL
676.532.281	3P+N+E	32	6	380-415	6	650,00 TL

Pano Fişleri

IP44 50/60 Hz.



Ürün Kodu	Kutup	I(A)	h	Volt		Fiyat
444.316.380	2P+E	16	4	110-130	12	240,00 TL
446.316.380	2P+E	16	6	200-250	12	210,00 TL
446.332.380	2P+E	32	6	200-250	12	325,00 TL
446.416.380	3P+E	16	6	380-415	12	250,00 TL
446.432.380	3P+E	32	6	380-415	12	350,00 TL
446.516.380	3P+N+E	16	6	380-415	12	300,00 TL
446.532.380	3P+N+E	32	6	380-415	12	380,00 TL

Dik Kasalı Duvar Fişleri

IP44 50/60 Hz.



Ürün Kodu	Kutup	I(A)	h	Volt		Fiyat
444.316.381	2P+E	16	4	110-130	10	340,00 TL
446.316.381	2P+E	16	6	200-250	10	310,00 TL
446.332.381	2P+E	32	6	200-250	5	425,00 TL
446.416.381	3P+E	16	6	380-415	10	350,00 TL
446.432.381	3P+E	32	6	380-415	5	450,00 TL
446.516.381	3P+N+E	16	6	380-415	10	380,00 TL
446.532.381	3P+N+E	32	6	380-415	6	460,00 TL

Eğik Duvar Fişleri

IP44 50/60 Hz.



Ürün Kodu	Kutup	I(A)	h	Volt		Fiyat
444.316.382	2P+E	16	4	110-130	10	370,00 TL
446.316.382	2P+E	16	6	200-250	10	340,00 TL
446.332.382	2P+E	32	6	200-250	6	475,00 TL
446.416.382	3P+E	16	6	380-415	10	380,00 TL
446.432.382	3P+E	32	6	380-415	6	500,00 TL
446.516.382	3P+N+E	16	6	380-415	10	450,00 TL
446.532.382	3P+N+E	32	6	380-415	6	530,00 TL

Eğik Duvar Fişleri + Monofaze

IP44 50/60 Hz.



Ürün Kodu	Kutup	I(A)	h	Volt		Fiyat
444.316.383	2P+E	16	4	110-130	10	450,00 TL
446.316.383	2P+E	16	6	200-250	10	420,00 TL
446.332.383	2P+E	32	6	200-250	6	555,00 TL
446.416.383	3P+E	16	6	380-415	10	460,00 TL
446.432.383	3P+E	32	6	380-415	6	580,00 TL
446.516.383	3P+N+E	16	6	380-415	10	530,00 TL
446.532.383	3P+N+E	32	6	380-415	6	610,00 TL

Uzatma 3'lü Çoklayıcı Prizler (Fiş Girişli)

IP44

6h

50/60 Hz.



Ürün Kodu	Kutup	I(A)	Volt		Fiyat
1344.316.333.0	3 (2P+E)	16	200-250	2	2.211,00 TL
1344.332.333.0	3 (2P+E)	32	200-250	4	4.475,00 TL
1344.416.333.0	4 (3P+E)	16	380-415	2	2.875,00 TL
1344.432.333.0	4 (3P+E)	32	380-415	2	4.919,00 TL
1344.516.333.0	5 (3P+N+E)	16	380-415	2	3.253,00 TL
1344.532.333.0	5 (3P+N+E)	32	380-415	2	5.198,00 TL

Uzatma 3'lü Çoklayıcı Prizler (Fiş Girişli)

IP67

6h

50/60 Hz.



Ürün Kodu	Kutup	I(A)	Volt		Fiyat
1367.316.333.0	3 (2P+E)	16	200-250	2	3.097,00 TL
1367.332.333.0	3 (2P+E)	32	200-250	4	4.910,00 TL
1367.416.333.0	4 (3P+E)	16	380-415	2	3.753,00 TL
1367.432.333.0	4 (3P+E)	32	380-415	2	5.282,00 TL
1367.516.333.0	5 (3P+N+E)	16	380-415	2	4.332,00 TL
1367.532.333.0	5 (3P+N+E)	32	380-415	2	5.521,00 TL

Uzatma 3'lü Çoklayıcı Prizler (Rekor Girişli)

IP44

6h

50/60 Hz.



Ürün Kodu	Kutup	I(A)	Volt		Fiyat
1344.316.333.1	3 (2P+E)	16	200-250	2	2.137,00 TL
1344.332.333.1	3 (2P+E)	32	200-250	4	3.253,00 TL
1344.416.333.1	4 (3P+E)	16	380-415	2	2.372,00 TL
1344.432.333.1	4 (3P+E)	32	380-415	2	3.369,00 TL
1344.516.333.1	5 (3P+N+E)	16	380-415	4	2.790,00 TL
1344.532.333.1	5 (3P+N+E)	32	380-415	4	3.717,00 TL

Uzatma 3'lü Çoklayıcı Prizler (Rekor Girişli)

IP67

6h

50/60 Hz.



Ürün Kodu	Kutup	I(A)	Volt		Fiyat
1367.316.333.1	3 (2P+E)	16	200-250	2	2.440,00 TL
1367.332.333.1	3 (2P+E)	32	200-250	4	3.717,00 TL
1367.416.333.1	4 (3P+E)	16	380-415	2	2.675,00 TL
1367.432.333.1	4 (3P+E)	32	380-415	2	3.834,00 TL
1367.516.333.1	5 (3P+N+E)	16	380-415	4	3.142,00 TL
1367.532.333.1	5 (3P+N+E)	32	380-415	4	4.184,00 TL

İçten Kilitli Şalterli Pano Prizi (Yatay Tip)

IP44

6h

50/60 Hz.



Ürün Kodu	Kutup	I(A)	Volt		Fiyat
1444.316.15	3 (2P+E)	16	200-250	1	2.012,00 TL
1444.332.15	3 (2P+E)	32	200-250	1	2.373,00 TL
1444.416.15	4 (3P+E)	16	380-415	1	2.320,00 TL
1444.432.15	4 (3P+E)	32	380-415	1	2.785,00 TL
1444.516.15	5 (3P+N+E)	16	380-415	1	2.568,00 TL
1444.532.15	5 (3P+N+E)	32	380-415	1	3.134,00 TL

İçten Kilitli Şalterli Pano Prizi (Yatay Tip)

IP67

6h

50/60 Hz.



Ürün Kodu	Kutup	I(A)	Volt		Fiyat
1467.316.15	3 (2P+E)	16	200-250	1	2.375,00 TL
1467.332.15	3 (2P+E)	32	200-250	1	2.854,00 TL
1467.416.15	4 (3P+E)	16	380-415	1	2.606,00 TL
1467.432.15	4 (3P+E)	32	380-415	1	3.104,00 TL
1467.516.15	5 (3P+N+E)	16	380-415	1	2.854,00 TL
1467.532.15	5 (3P+N+E)	32	380-415	1	3.353,00 TL

İçten Kilitli Şalterli Duvar Prizi (Yatay Tip)

IP44

6h

50/60 Hz.



Ürün Kodu	Kutup	I(A)	Volt		Fiyat
1444.316.10	3 (2P+E)	16	200-250	1	2.235,00 TL
1444.332.10	3 (2P+E)	32	200-250	1	2.623,00 TL
1444.416.10	4 (3P+E)	16	380-415	1	2.470,00 TL
1444.432.10	4 (3P+E)	32	380-415	1	2.980,00 TL
1444.516.10	5 (3P+N+E)	16	380-415	1	2.728,00 TL
1444.532.10	5 (3P+N+E)	32	380-415	1	3.225,00 TL

İçten Kilitli Şalterli Duvar Prizi (Yatay Tip)

IP67

6h

50/60 Hz.



Ürün Kodu	Kutup	I(A)	Volt		Fiyat
1467.316.10	3 (2P+E)	16	200-250	1	2.606,00 TL
1467.332.10	3 (2P+E)	32	200-250	1	3.104,00 TL
1467.416.10	4 (3P+E)	16	380-415	1	2.854,00 TL
1467.432.10	4 (3P+E)	32	380-415	1	3.353,00 TL
1467.516.10	5 (3P+N+E)	16	380-415	1	3.104,00 TL
1467.532.10	5 (3P+N+E)	32	380-415	1	3.599,00 TL

İçten Kilitli Şalterli Pano Prizi (Dikey Tip)

IP44

6h

50/60 Hz.



Ürün Kodu	Kutup	I(A)	Volt		Fiyat
1944.316.15	3 (2P+E)	16	200-250	1	1.993,00 TL
1944.332.15	3 (2P+E)	32	200-250	1	2.489,00 TL
1944.416.15	4 (3P+E)	16	380-415	1	2.216,00 TL
1944.432.15	4 (3P+E)	32	380-415	1	2.861,00 TL
1444.516.15	5 (3P+N+E)	16	380-415	1	2.472,00 TL
1444.532.15	5 (3P+N+E)	32	380-415	1	3.125,00 TL

İçten Kilitli Şalterli Pano Prizi (Dikey Tip)

IP67

6h

50/60 Hz.



Ürün Kodu	Kutup	I(A)	Volt		Fiyat
1967.316.15	3 (2P+E)	16	200-250	1	2.472,00 TL
1967.332.15	3 (2P+E)	32	200-250	1	2.993,00 TL
1967.416.15	4 (3P+E)	16	380-415	1	2.733,00 TL
1967.432.15	4 (3P+E)	32	380-415	1	3.255,00 TL
1967.516.15	5 (3P+N+E)	16	380-415	1	2.993,00 TL
1967.532.15	5 (3P+N+E)	32	380-415	1	3.517,00 TL

İçten Kilitli Şalterli Duvar Prizi (Dikey Tip)

IP44

6h

50/60 Hz.



Ürün Kodu	Kutup	I(A)	Volt		Fiyat
1944.316.10	3 (2P+E)	16	200-250	1	2.344,00 TL
1944.332.10	3 (2P+E)	32	200-250	1	2.751,00 TL
1944.416.10	4 (3P+E)	16	380-415	1	2.591,00 TL
1944.432.10	4 (3P+E)	32	380-415	1	3.125,00 TL
1944.516.10	5 (3P+N+E)	16	380-415	1	2.861,00 TL
1944.532.10	5 (3P+N+E)	32	380-415	1	3.383,00 TL

İçten Kilitli Şalterli Duvar Prizi (Dikey Tip)

IP67

6h

50/60 Hz.



Ürün Kodu	Kutup	I(A)	Volt		Fiyat
1967.316.10	3 (2P+E)	16	200-250	1	2.733,00 TL
1967.332.10	3 (2P+E)	32	200-250	1	3.255,00 TL
1967.416.10	4 (3P+E)	16	380-415	1	2.993,00 TL
1967.432.10	4 (3P+E)	32	380-415	1	3.517,00 TL
1967.516.10	5 (3P+N+E)	16	380-415	1	3.255,00 TL
1967.532.10	5 (3P+N+E)	32	380-415	1	3.774,00 TL

İçten Kilitli Şalterli Sigortalı Pano Prizi

IP44

6h

50/60 Hz.



Ürün Kodu	Kutup	I(A)	Volt		Fiyat
1644.316.15	3 (2P+E)	16	200-250	1	3.055,00 TL
1644.332.15	3 (2P+E)	32	200-250	1	3.853,00 TL
1644.416.15	4 (3P+E)	16	380-415	1	3.321,00 TL
1644.432.15	4 (3P+E)	32	380-415	1	4.251,00 TL
1644.516.15	5 (3P+N+E)	16	380-415	1	3.589,00 TL
1644.532.15	5 (3P+N+E)	32	380-415	1	4.519,00 TL

İçten Kilitli Şalterli Sigortalı Pano Prizi

IP67

6h

50/60 Hz.



Ürün Kodu	Kutup	I(A)	Volt		Fiyat
1667.316.15	3 (2P+E)	16	200-250	1	3.189,00 TL
1667.332.15	3 (2P+E)	32	200-250	1	3.985,00 TL
1667.416.15	4 (3P+E)	16	380-415	1	3.453,00 TL
1667.432.15	4 (3P+E)	32	380-415	1	4.385,00 TL
1667.516.15	5 (3P+N+E)	16	380-415	1	3.719,00 TL
1667.532.15	5 (3P+N+E)	32	380-415	1	4.649,00 TL

İçten Kilitli Şalterli Sigortalı Duvar Prizi

IP44

6h

50/60 Hz.



Ürün Kodu	Kutup	I(A)	Volt		Fiyat
1644.316.10	3 (2P+E)	16	200-250	1	3.453,00 TL
1644.332.10	3 (2P+E)	32	200-250	1	4.251,00 TL
1644.416.10	4 (3P+E)	16	380-415	1	3.719,00 TL
1644.432.10	4 (3P+E)	32	380-415	1	4.649,00 TL
1644.516.10	5 (3P+N+E)	16	380-415	1	3.985,00 TL
1644.532.10	5 (3P+N+E)	32	380-415	1	4.917,00 TL

İçten Kilitli Şalterli Sigortalı Duvar Prizi

IP67

6h

50/60 Hz.



Ürün Kodu	Kutup	I(A)	Volt		Fiyat
1667.316.10	3 (2P+E)	16	200-250	1	3.589,00 TL
1667.332.10	3 (2P+E)	32	200-250	1	4.477,00 TL
1667.416.10	4 (3P+E)	16	380-415	1	3.853,00 TL
1667.432.10	4 (3P+E)	32	380-415	1	4.783,00 TL
1667.516.10	5 (3P+N+E)	16	380-415	1	4.121,00 TL
1667.532.10	5 (3P+N+E)	32	380-415	1	5.051,00 TL

Ürün Kodu	IP44 Kombinasyon Kutuları		Fiyat
341	Boş Mbox	1	400,00 TL
341.364.30	3 Ad. 3x16A CEE	1	1.202,00 TL
341.324.30	3 Ad. 3x32A CEE	1	1.564,00 TL
341.464.30	3 Ad. 4x16A CEE	1	1.357,00 TL
341.424.30	3 Ad. 4x32A CEE	1	1.719,00 TL
341.564.30	3 Ad. 5x16A CEE	1	1.564,00 TL
341.524.30	3 Ad. 5x32A CEE	1	1.806,00 TL
341.524.164.210	2 Ad. 5x32A CEE + 1 Ad. 1x16A Makine Prizi	1	1.484,00 TL
341.524.164.120	1 Ad. 5x32A CEE + 2 Ad. 1x16A Makine Prizi	1	1.162,00 TL
341.524.564.164.1110	1 Ad. 5x32A CEE + 1 Ad. 5x16A CEE + 1 Ad. 1x16A Makine Prizi	1	1.403,00 TL
341.215.311.60	6 Ad. Şebeke Pano prizi	1	1.026,00 TL
341.215.321.60	6 Ad. UPS Pano prizi	1	1.095,00 TL

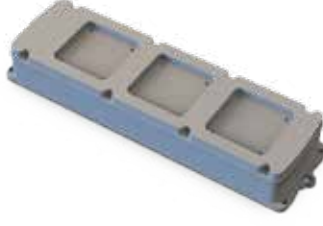

Ürün Kodu	IP67 Kombinasyon Kutuları		Fiyat
361	Boş Mbox	1	480,00 TL
361.324.30	3 Ad. 3x32A CEE	1	2.104,00 TL
361.464.30	3 Ad. 4x16A CEE	1	1.898,00 TL
361.424.30	3 Ad. 4x32A CEE	1	2.260,00 TL
361.564.30	3 Ad. 5x16A CEE	1	2.105,00 TL
361.524.30	3 Ad. 5x32A CEE	1	2.530,00 TL
361.524.164.210	2 Ad. 5x32A CEE + 1 Ad. 1x16A Makine Prizi	1	2.116,00 TL
361.524.164.120	1 Ad. 5x32A CEE + 2 Ad. 1x16A Makine Prizi	1	1.334,00 TL
361.524.564.164.1110	1 Ad. 5x32A CEE + 1 Ad. 5x16A CEE + 1 Ad. 1x16A Makine Prizi	1	1.852,00 TL

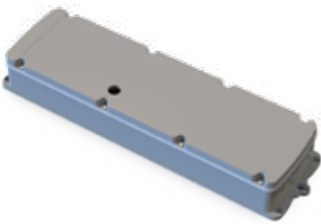

**260x350mm Priz Montajlı Sigortalı Kombinasyon Kutuları
(12 Sigorta Kapasiteli)**

Ürün Kodu	IP44 Kombinasyon Kutuları		Fiyat
E.44120	Boş Ecobox	1	725,00 TL
E.4412.3160.024	2 Ad. IP44 3x16A CEE Ön + 4 Ad. IP44 1x16A Ön	1	1.511,00 TL
E.4412.3320.024	2 Ad. IP44 3x32A CEE Ön + 4 Ad. IP44 1x16A Ön	1	1.721,00 TL
E.4412.4160.024	2 Ad. IP44 4x16A CEE Ön + 4 Ad. IP44 1x16A Ön	1	1.601,00 TL
E.4412.4320.024	2 Ad. IP44 4x32A CEE Ön + 4 Ad. IP44 1x16A Ön	1	1.551,00 TL
E.4412.5160.024	2 Ad. IP44 5x16A CEE Ön + 4 Ad. IP44 1x16A Yan	1	1.721,00 TL
E.4412.5320.024	2 Ad. IP44 5x32A CEE Ön + 4 Ad. IP44 1x16A Yan	1	1.981,00 TL

Ürün Kodu	IP67 Kombinasyon Kutuları		Fiyat
E.62120	Boş Ecobox	1	760,00 TL
E.6212.3161.024	2 Ad. IP67 3x16A CEE Ön + 4 Ad. IP44 1x16A Ön	1	1.806,00 TL
E.6212.3321.024	2 Ad. IP67 3x32A CEE Ön + 4 Ad. IP44 1x16A Ön	1	2.016,00 TL
E.6212.4161.024	2 Ad. IP67 4x16A CEE Ön + 4 Ad. IP44 1x16A Ön	1	1.896,00 TL
E.6212.4321.024	2 Ad. IP67 4x32A CEE Ön + 4 Ad. IP44 1x16A Ön	1	2.106,00 TL
E.6212.5161.024	2 Ad. IP67 5x16A CEE Ön + 4 Ad. IP44 1x16A Yan	1	2.016,00 TL
E.6212.5321.024	2 Ad. IP67 5x32A CEE Ön + 4 Ad. IP44 1x16A Yan	1	2.156,00 TL



E.6212



E.4212.3160.024



E.4212.4320.024





E.62120.5321.024



E.4412.5320.024

**260x350mm Priz Montajlı Sigortalı Kombinasyon Kutuları
(12 Sigorta Kapasiteli)**

Ürün Kodu	IP44 Kombinasyon Kutuları		Fiyat
44120	260x350x120mm IP44 Boş Kombinasyon Kutusu	1	810,00 TL
44120.4160.1160.224	2 Ad. IP44 4x16A CEE + 2 Ad. IP44 1x16A Ön + 4 Ad. IP44 1x16A Yan	1	1.906,00 TL
44120.3163.0000.044	4 Ad. IP44 3x16A Ön + 4 Ad. 1x16 Yan	1	1.926,00 TL
44120.3323.3163.224	2 Ad. IP44 3x32A Ön + 2 Ad. IP44 3x16 Ön + 4 Ad. 1x16A Yan	1	2.016,00 TL
44120.3323.0000.044	4 Ad. IP44 3x32A Ön + 4 Ad. 1x16A Yan	1	2.106,00 TL
44120.4320.4250.222	2 Ad. IP44 4x32A CEE Ön + 2 Ad. IP44 4x25A Ön + 2 Ad. 1x16A Yan	1	2.038,00 TL
44120.4250.0000.044	4 Ad. IP44 4x25A Ön + 4 Ad. 1x16A Yan	1	1.806,00 TL
44120.4320.0000.046	4 Ad. IP44 4x32A CEE Ön + 6 Ad. 1x16A Yan	1	2.804,00 TL
44120.4321.0000.044	4 Ad. IP67 4x32A CEE Ön + 4 Ad. 1x16A Yan	1	3.146,00 TL
44120.4631.4321.222	2 Ad. IP67 4x63A CEE Ön + 2 Ad. IP67 4x32A CEE Ön + 2 Ad. 1x16 Yan	1	4.278,00 TL
44120.4630.0000.028	2 Ad. IP44 4x63A CEE Ön + 4 Ad. 1x16A Ön + 4 Ad. 1x16 Yan	1	3.472,00 TL
44120.5160.0000.022	2 Ad. IP44 5x16A CEE Ön + 2 Ad. 1x16 Yan	1	1.628,00 TL
44120.5320.0000.022	2 Ad. IP44 5x32A CEE Ön + 2 Ad. 1x16 Yan	1	1.768,00 TL
44120.5320.5160.222	2 Ad. IP44 5x32A CEE Ön + 2 Ad. IP44 5x16A CEE Ön + 2 Ad. 1x16 Yan	1	2.408,00 TL
44120.5321.0000.046	4 Ad. IP67 5x32A CEE Ön + 6 Ad. 1x16A Yan	1	3.424,00 TL
44120.5631.5321.222	2 Ad. IP67 5x63A CEE Ön + 2 Ad. IP67 5x32A CEE Ön + 2 Ad. 1x16A Yan	1	4.928,00 TL

Ürün Kodu	IP67 Kombinasyon Kutuları		Fiyat
64120	260x350x120mm IP67 Boş Kombinasyon Kutusu	1	860,00 TL
64120.4160.1160.224	2 Ad. IP44 4x16A CEE + 2 Ad. IP44 1x16A Ön + 4 Ad. IP44 1x16A Yan	1	1.956,00 TL
64120.3163.0000.044	4 Ad. IP44 3x16A Ön + 4 Ad. 1x16 Yan	1	1.976,00 TL
64120.3323.3163.224	2 Ad. IP44 3x32A Ön + 2 Ad. IP44 3x16 Ön + 4 Ad. 1x16A Yan	1	2.066,00 TL
64120.3323.0000.044	4 Ad. IP44 3x32A Ön + 4 Ad. 1x16A Yan	1	2.156,00 TL
64120.4320.4250.222	2 Ad. IP44 4x32A CEE Ön + 2 Ad. IP44 4x25A Ön + 2 Ad. 1x16A Yan	1	2.088,00 TL
64120.4250.0000.044	4 Ad. IP44 4x25A Ön + 4 Ad. 1x16A Yan	1	1.856,00 TL
64120.4320.0000.046	4 Ad. IP44 4x32A CEE Ön + 6 Ad. 1x16A Yan	1	2.854,00 TL
64120.4321.0000.044	4 Ad. IP67 4x32A CEE Ön + 4 Ad. 1x16A Yan	1	3.196,00 TL
64120.4631.4321.222	2 Ad. IP67 4x63A CEE Ön + 2 Ad. IP67 4x32A CEE Ön + 2 Ad. 1x16 Yan	1	4.328,00 TL
64120.4630.0000.028	2 Ad. IP44 4x63A CEE Ön + 4 Ad. 1x16A Ön + 4 Ad. 1x16 Yan	1	3.522,00 TL
64120.5160.0000.022	2 Ad. IP44 5x16A CEE Ön + 2 Ad. 1x16 Yan	1	1.678,00 TL
64120.5320.0000.022	2 Ad. IP44 5x32A CEE Ön + 2 Ad. 1x16 Yan	1	1.818,00 TL
64120.5320.5160.222	2 Ad. IP44 5x32A CEE Ön + 2 Ad. IP44 5x16A CEE Ön + 2 Ad. 1x16 Yan	1	2.458,00 TL
64120.5321.0000.046	4 Ad. IP67 5x32A CEE Ön + 6 Ad. 1x16A Yan	1	3.474,00 TL
64120.5631.5321.222	2 Ad. IP67 5x63A CEE Ön + 2 Ad. IP67 5x32A CEE Ön + 2 Ad. 1x16A Yan	1	4.978,00 TL



64120



64120.4160.0000.028



64120.4160.3160.224





64120.5320.5160.224



64120.4321.5321.220

**210x280mm Priz Montajlı Sigortalı Kombinasyon Kutuları
(10 Sigorta Kapasiteli)**

Ürün Kodu	IP44 Kombinasyon Kutuları		Fiyat
42100	210x280x100mm IP44 Boş Kombinasyon Kutusu	1	560,00 TL
42100.4160.0000.011	1 Ad. IP44 4x16A CEE Ön + 1 Ad. 1x16A Ön	1	904,00 TL
42100.4160.0000.012	1 Ad. IP44 4x16A CEE Ön + 2 Ad. 1x16A Ön	1	988,00 TL
42100.4160.0000.022	2 Ad. IP44 4x16A CEE Ön + 2 Ad. 1x16A Yan	1	1.248,00 TL
42100.4250.0000.022	2 Ad. IP44 4x25A Ön + 2 Ad. 1x16A Yan	1	1.048,00 TL
42100.4320.0000.022	2 Ad. IP44 4x32A CEE Ön + 2 Ad. 1x16A Yan	1	1.458,00 TL
42100.4321.0000.024	2 Ad. IP67 4x32A CEE Ön + 4 Ad. 1x16A Yan	1	1.886,00 TL
42100.5160.0000.022	2 Ad. IP44 5x16A CEE Ön + 2 Ad. 1x16A Yan	1	1.368,00 TL
42100.5320.0000.012	1 Ad. IP44 5x32A CEE Ön + 2 Ad. 1x16A Ön	1	1.118,00 TL
42100.5320.0000.022	2 Ad. IP44 5x32A CEE Ön + 2 Ad. 1x16A Yan	1	1.508,00 TL
42100.5160.0000.012	1 Ad. IP44 5x16A CEE Ön + 2 Ad. 1x16A Yan	1	1.058,00 TL
42100.5320.5160.112	1 Ad. IP44 5x32A CEE Ön + 1 Ad. IP44 5x16A CEE Ön + 2 Ad. 1x16A Yan	1	1.448,00 TL
42100.3163.0000.022	2 Ad. IP44 3x16A Ön + 2 Ad. 1x16A Yan	1	1.108,00 TL
42100.3323.3163.112	1 Ad. IP44 3x32A Ön + 1 Ad. IP44 3x16A Ön + 2 Ad. 1x16A Yan	1	1.153,00 TL
42100.3323.0000.022	2 Ad. IP44 3x32A Ön + 2 Ad. 1x16A Yan	1	1.198,00 TL

Ürün Kodu	IP67 Kombinasyon Kutuları		Fiyat
62100	210x280x100mm IP67 Boş Kombinasyon Kutusu	1	610,00 TL
62100.4160.0000.011	1 Ad. IP44 4x16A CEE Ön + 1 Ad. 1x16A Ön	1	959,00 TL
62100.4160.0000.012	1 Ad. IP44 4x16A CEE Ön + 2 Ad. 1x16A Ön	1	1.048,00 TL
62100.4160.0000.022	2 Ad. IP44 4x16A CEE Ön + 2 Ad. 1x16A Yan	1	1.308,00 TL
62100.4250.0000.022	2 Ad. IP44 4x25A Ön + 2 Ad. 1x16A Yan	1	1.108,00 TL
62100.0000.4320.022	2 Ad. IP44 4x32A CEE Ön + 2 Ad. 1x16A Yan	1	1.518,00 TL
62100.4321.0000.024	2 Ad. IP67 4x32A CEE Ön + 4 Ad. 1x16A Yan	1	1.956,00 TL
62100.5160.0000.022	2 Ad. IP44 5x16A CEE Ön + 2 Ad. 1x16A Yan	1	1.428,00 TL
62100.5320.0000.012	1 Ad. IP44 5x32A CEE Ön + 2 Ad. 1x16A Ön	1	1.178,00 TL
62100.5320.0000.022	2 Ad. IP44 5x32A CEE Ön + 2 Ad. 1x16A Yan	1	1.568,00 TL
62100.5160.0000.012	1 Ad. IP44 5x16A CEE Ön + 2 Ad. 1x16A Yan	1	1.428,00 TL
62100.5320.5160.112	1 Ad. IP44 5x32A CEE Ön + 1 Ad. IP44 5x16A CEE Ön + 2 Ad. 1x16A Yan	1	1.498,00 TL
62100.3163.0000.022	2 Ad. IP44 3x16A Ön + 2 Ad. 1x16A Yan	1	1.168,00 TL
62100.3323.3163.112	1 Ad. IP44 3x32A Ön + 1 Ad. IP44 3x16A Ön + 2 Ad. 1x16A Yan	1	1.213,00 TL
62100.3323.0000.022	2 Ad. IP44 3x32A Ön + 2 Ad. 1x16A Yan	1	1.258,00 TL



62100



62100.3163.0000.022



62100.4160.0000.012





62100.4320.0000.022



62100.5321.0000.020

**210x280mm Priz Montajlı Sigortalı Kombinasyon Kutuları
(8 Sigorta Kapasiteli)**

Ürün Kodu	IP44 Kombinasyon Kutuları		Fiyat
42080	210x280x100mm IP44 Boş Kombinasyon Kutusu	1	510,00 TL
42080.4160.0000.011	1 Ad. IP44 4x16A CEE Ön + 1 Ad. 1x16A Ön	1	859,00 TL
42080.4160.0000.012	1 Ad. IP44 4x16A CEE Ön + 2 Ad. 1x16A Ön	1	948,00 TL
42080.4160.0000.022	2 Ad. IP44 4x16A CEE Ön + 2 Ad. 1x16A Yan	1	1.208,00 TL
42080.4250.0000.022	2 Ad. IP44 4x25A Ön + 2 Ad. 1x16A Yan	1	1.008,00 TL
42080.4320.0000.022	2 Ad. IP44 4x32A CEE Ön + 2 Ad. 1x16A Yan	1	1.418,00 TL
42080.4321.0000.024	2 Ad. IP67 4x32A CEE Ön + 4 Ad. 1x16A Yan	1	1.856,00 TL
42080.5160.0000.022	2 Ad. IP44 5x16A CEE Ön + 2 Ad. 1x16A Yan	1	1.328,00 TL
42080.5320.0000.012	1 Ad. IP44 5x32A CEE Ön + 2 Ad. 1x16A Ön	1	1.078,00 TL
42080.5320.0000.022	2 Ad. IP44 5x32A CEE Ön + 2 Ad. 1x16A Yan	1	1.468,00 TL
42080.5160.0000.012	1 Ad. IP44 5x16A CEE Ön + 2 Ad. 1x16A Ön	1	1.008,00 TL
42080.3163.0000.022	2 Ad. IP44 3x16A Ön + 2 Ad. 1x16A Yan	1	1.068,00 TL
42080.3323.3163.112	1 Ad. IP44 3x32A Ön + 1 Ad. IP44 3x16A Ön + 2 Ad. 1x16A Yan	1	1.113,00 TL
42080.3323.0000.022	2 Ad. IP44 3x32A Ön + 2 Ad. 1x16A Yan	1	1.158,00 TL

Ürün Kodu	IP67 Kombinasyon Kutuları		Fiyat
62080	210x280x100mm IP67 Boş Kombinasyon Kutusu	1	550,00 TL
62080.4160.0000.011	1 Ad. IP44 4x16A CEE Ön + 1 Ad. 1x16A Ön	1	899,00 TL
62080.4160.0000.012	1 Ad. IP44 4x16A CEE Ön + 2 Ad. 1x16A Ön	1	988,00 TL
62080.4160.0000.022	2 Ad. IP44 4x16A CEE Ön + 2 Ad. 1x16A Yan	1	1.248,00 TL
62080.4250.0000.022	2 Ad. IP44 4x25A Ön + 2 Ad. 1x16A Yan	1	1.048,00 TL
62080.4320.0000.022	2 Ad. IP44 4x32A CEE Ön + 2 Ad. 1x16A Yan	1	1.458,00 TL
62080.4321.0000.024	2 Ad. IP67 4x32A CEE Ön + 4 Ad. 1x16A Yan	1	1.896,00 TL
62080.5160.0000.022	2 Ad. IP44 5x16A CEE Ön + 2 Ad. 1x16A Yan	1	1.368,00 TL
62080.5320.0000.012	1 Ad. IP44 5x32A CEE Ön + 2 Ad. 1x16A Ön	1	1.118,00 TL
62080.5320.0000.022	2 Ad. IP44 5x32A CEE Ön + 2 Ad. 1x16A Yan	1	1.508,00 TL
62080.5160.0000.012	1 Ad. IP44 5x16A CEE Ön + 2 Ad. 1x16A Ön	1	1.048,00 TL
62080.3163.0000.022	2 Ad. IP44 3x16A Ön + 2 Ad. 1x16A Yan	1	1.108,00 TL
62080.3323.3163.112	1 Ad. IP44 3x32A Ön + 1 Ad. IP44 3x16A Ön + 2 Ad. 1x16A Yan	1	1.153,00 TL
62080.3323.0000.022	2 Ad. IP44 3x32A Ön + 2 Ad. 1x16A Yan	1	1.198,00 TL



62080



62080.3160.62080.022



62080.4160.0000.012



62080.4320.0000.022



452.5321.0000.020

**135x250mm Priz Montajlı Sigortalı Kombinasyon Kutuları
(6 Sigorta Kapasiteli)**

HALOJEN FREE

Ürün Kodu	IP44 Kombinasyon Kutuları		Fiyat
41060	135x250x120mm IP44 Boş Kombinasyon Kutusu		2 355,00 TL
41060.3163.0000.012	1 Ad. IP44 3x16A Ön + 2 Ad. 1x16A Yan		2 723,00 TL
41060.3323.0000.012	1 Ad. IP44 3x32A Ön + 2 Ad. 1x16A Yan		2 768,00 TL
41060.4250.0000.012	1 Ad. IP44 4x25A Ön + 2 Ad. 1x16A Yan		2 693,00 TL
41060.4160.0000.012	1 Ad. IP44 4x16A CEE Ön + 2 Ad. 1x16A Yan		2 793,00 TL
41060.4320.0000.012	1 Ad. IP44 4x32A CEE Ön + 2 Ad. 1x16A Yan		2 898,00 TL
41060.5160.0000.012	1 Ad. IP44 5x16A CEE Ön + 2 Ad. 1x16A Yan		2 853,00 TL
41060.5320.0000.012	1 Ad. IP44 5x32A CEE Ön + 2 Ad. 1x16A Yan		2 923,00 TL

41060

Ürün Kodu	IP67 Kombinasyon Kutuları		Fiyat
61060	135x250x120mm IP67 Boş Kombinasyon Kutusu		2 395,00 TL
61060.3163.0000.012	1 Ad. IP44 3x16A Ön + 2 Ad. 1x16A Yan		2 763,00 TL
61060.3323.0000.012	1 Ad. IP44 3x32A Ön + 2 Ad. 1x16A Yan		2 808,00 TL
61060.4250.0000.012	1 Ad. IP44 4x25A Ön + 2 Ad. 1x16A Yan		2 733,00 TL
61060.4160.0000.012	1 Ad. IP44 4x16A CEE Ön + 2 Ad. 1x16A Yan		2 833,00 TL
61060.4320.0000.012	1 Ad. IP44 4x32A CEE Ön + 2 Ad. 1x16A Yan		2 938,00 TL
61060.5160.0000.012	1 Ad. IP44 5x16A CEE Ön + 2 Ad. 1x16A Yan		2 893,00 TL
61060.5320.0000.012	1 Ad. IP44 5x32A CEE Ön + 2 Ad. 1x16A Yan		2 963,00 TL

61060

**113x210mm Priz Montajlı Sigortalı Kombinasyon Kutuları
(4 Sigorta Kapasiteli)**

HALOJEN FREE

Ürün Kodu	IP44 Kombinasyon Kutuları		Fiyat
41040	113x210x90mm IP44 Boş Kombinasyon Kutusu		3 290,00 TL
41040.3163.0000.012	1 Ad. IP44 3x16A Ön + 2 Ad. 1x16A Yan		3 658,00 TL
41040.3323.0000.012	1 Ad. IP44 3x32A Ön + 2 Ad. 1x16A Yan		3 703,00 TL
41040.4250.0000.012	1 Ad. IP44 4x25A Ön + 2 Ad. 1x16A Yan		3 628,00 TL
41040.4160.0000.012	1 Ad. IP44 4x16A CEE Ön + 2 Ad. 1x16A Yan		3 728,00 TL
41040.4320.0000.012	1 Ad. IP44 4x32A CEE Ön + 2 Ad. 1x16A Yan		3 833,00 TL
41040.5160.0000.012	1 Ad. IP44 5x16A CEE Ön + 2 Ad. 1x16A Yan		3 788,00 TL
41040.5320.0000.012	1 Ad. IP44 5x32A CEE Ön + 2 Ad. 1x16A Yan		3 858,00 TL

41040

Ürün Kodu	IP67 Kombinasyon Kutuları		Fiyat
61040	113x210x90mm IP67 Boş Kombinasyon Kutusu		3 320,00 TL
61040.3163.0000.012	1 Ad. IP44 3x16A Ön + 2 Ad. 1x16A Yan		3 688,00 TL
61040.3323.0000.012	1 Ad. IP44 3x32A Ön + 2 Ad. 1x16A Yan		3 733,00 TL
61040.4250.0000.012	1 Ad. IP44 4x25A Ön + 2 Ad. 1x16A Yan		3 658,00 TL
61040.4160.0000.012	1 Ad. IP44 4x16A CEE Ön + 2 Ad. 1x16A Yan		3 758,00 TL
61040.4320.0000.012	1 Ad. IP44 4x32A CEE Ön + 2 Ad. 1x16A Yan		3 863,00 TL
61040.5160.0000.012	1 Ad. IP44 5x16A CEE Ön + 2 Ad. 1x16A Yan		3 818,00 TL
61040.5320.0000.012	1 Ad. IP44 5x32A CEE Ön + 2 Ad. 1x16A Yan		3 888,00 TL

61040

**113x210mm Priz Montajlı Sigortalı Kombinasyon Kutuları
(4 Sigorta Kapasiteli)**

HALOJEN FREE

Ürün Kodu	IP44 Kombinasyon Kutuları		Fiyat
3540	113x210x90mm IP44 Boş Kombinasyon Kutusu	3	240,00 TL
3540.3320.012	1 Ad. IP44 3x32A CEE Ön + 2 Ad. 1x16A Yan	3	738,00 TL
3540.4160.012	1 Ad. IP44 4x16A CEE Ön + 2 Ad. IP44 1x16A Yan	3	678,00 TL
3540.3163.012	1 Ad. IP44 3x16A Ön + 2 Ad. 1x16A Yan	3	608,00 TL
3540.3323.012	1 Ad. IP44 3x32A Ön + 2 Ad. 1x16A Yan	3	653,00 TL



3540



3540.3320.012



3540.4160.012



3540.3163.012



3540.3323.012

Priz Montajlı Sigortasız Kombinasyon Kutuları

HALOJEN FREE

Ürün Kodu	IP44 Kombinasyon Kutuları		Fiyat
44000	210x280x100mm IP44 Boş Kombinasyon Kutusu	1	420,00 TL
44000.4320.4160.224	2 Ad. IP44 4x32A CEE Ön + 2 Ad. IP44 4x16A CEE Ön + 4 Ad. 1x16A Yan	1	2.026,00 TL
44000.4320.5160.220	2 Ad. IP44 4x32A CEE Ön + 2 Ad. IP44 5x16A CEE Ön	1	1.790,00 TL
41000	113x113x73mm IP44 Boş Kombinasyon Kutusu	6	132,00 TL
41000.4160.0000.012	1 Ad. IP44 4x16A CEE Ön + 2 Ad. 1x16A Yan	6	570,00 TL
41000.5160.0000.012	1 Ad. IP44 5x16A CEE Ön + 2 Ad. 1x16A Yan	6	630,00 TL
42000	210x113x73mm IP44 Boş Kombinasyon Kutusu	3	210,00 TL
42000.4320.0000.022	2 Ad. IP44 4x32A CEE Ön + 2 Ad. 1x16A Yan	3	1.118,00 TL
42000.5320.0000.022	2 Ad. IP44 5x32A CEE Ön + 2 Ad. 1x16A Yan	3	1.168,00 TL

Ürün Kodu	IP67 Kombinasyon Kutuları		Fiyat
64000	210x280x100mm IP67 Boş Kombinasyon Kutusu	1	440,00 TL
64000.4321.4161.224	2 Ad. IP67 4x32A CEE Ön + 2 Ad. IP67 4x16A CEE Ön + 4 Ad. 1x16A Yan	1	2.566,00 TL
64000.4320.5160.220	2 Ad. IP44 4x32A CEE Ön + 2 Ad. IP44 5x16A CEE Ön	1	1.810,00 TL
61000	113x113x73mm IP67 Boş Kombinasyon Kutusu	6	165,00 TL
61000.4160.0000.012	1 Ad. IP44 4x16A CEE Ön + 2 Ad. 1x16A Yan	6	603,00 TL
61000.5160.0000.012	1 Ad. IP44 5x16A CEE Ön + 2 Ad. 1x16A Yan	6	663,00 TL
62000	210x113x73mm IP67 Boş Kombinasyon Kutusu	3	230,00 TL
62000.4320.0000.022	2 Ad. IP44 4x32A CEE Ön + 2 Ad. 1x16A Yan	3	908,00 TL
62000.5320.0000.022	2 Ad. IP44 5x32A CEE Ön + 2 Ad. 1x16A Yan	3	958,00 TL



64000



64000.4321.4161.224



64000.4320.5160.220



62000.4320.0000.022



61000.4160.0000.012

Küçük Boy Taşıyıcı Ayak

Ürün Kodu	Açıklama	Ölçü (mm)		Fiyat
740.022.001	(351 - 451 - 352 - 452 - 361) Kombinasyonlar + (21x30 - 26x35 30x40) Panolar	310x610	1	950,00 TL

**Büyük Boy Taşıyıcı Ayak**

Ürün Kodu	Açıklama	Ölçü (mm)		Fiyat
740.022.002	(40x50 - 40x60 - 50x70) Panolar	510x1010	1	1.150,00 TL



Opak Kapaklı Termoplastik Buatlar

HALOJEN FREE

IP44 Ürün Kodu	IP67 Ürün Kodu	Dış Ölçü(mm)		IP44 Fiyat	IP67 Fiyat
344.041.101	-	85 x 85 x 41	24	45,00 TL	
344.055.201	367.055.201	95 x 95 x 55	12	69,00 TL	72,00 TL
344.073.301	367.073.301	113 x 113 x 73	12	129,00 TL	135,00 TL
344.120.301	367.120.301	113 x 113 x 120	6	132,00 TL	165,00 TL
344.073.401	367.073.401	113 x 210 x 73	6	210,00 TL	230,00 TL
344.120.401	367.120.401	113 x 210 x 120	3	231,00 TL	242,00 TL
344.085.421	367.085.421	130 x 245 x 85	2	260,00 TL	273,00 TL
344.140.421	367.140.421	130 x 245 x 140	2	319,00 TL	335,00 TL
344.100.501	367.100.501	210 x 280 x 100	1	420,00 TL	440,00 TL
344.135.601	367.135.601	210 x 280 x 135	1	433,00 TL	455,00 TL
344.115.501	367.115.501	260 x 350 x 115	1	657,00 TL	690,00 TL
344.145.601	367.145.601	260 x 350 x 145	1	705,00 TL	741,00 TL
344.155.601	367.155.601	260 x 350 x 155	1	722,00 TL	758,00 TL
344.185.601	367.185.601	260 x 350 x 185	1	779,00 TL	818,00 TL



367.073.301



367.073.401



367.100.501



367.135.601



367.155.601

Şeffaf Kapaklı Termoplastik Buatlar

HALOJEN FREE

IP44 Ürün Kodu	IP67 Ürün Kodu	Dış Ölçü(mm)		IP44 Fiyat	IP67 Fiyat
344.055.202	367.055.202	95 x 95 x 55	12	78,00 TL	81,00 TL
344.073.302	367.073.302	113 x 113 x 73	12	127,00 TL	133,00 TL
344.120.302	367.120.302	113 x 113 x 120	6	159,00 TL	167,00 TL
344.073.402	367.073.402	113 x 210 x 73	6	197,00 TL	207,00 TL
344.120.402	367.120.402	113 x 210 x 120	3	269,00 TL	282,00 TL
344.085.422	367.085.422	130 x 245 x 85	2	286,00 TL	301,00 TL
344.140.422	367.140.422	130 x 245 x 140	2	322,00 TL	338,00 TL
344.100.502	367.100.502	210 x 280 x 100	1	465,00 TL	489,00 TL
344.135.602	367.135.602	210 x 280 x 135	1	492,00 TL	517,00 TL
344.115.502	367.115.502	260 x 350 x 115	1	740,00 TL	777,00 TL
344.145.602	367.145.602	260 x 350 x 145	1	788,00 TL	827,00 TL
344.155.602	367.155.602	260 x 350 x 155	1	791,00 TL	831,00 TL
344.185.602	367.185.602	260 x 350 x 185	1	845,00 TL	887,00 TL



367.073.302



367.073.402



367.100.502



367.135.602



367.155.602

Montaj Plakalı

IP65

HALOJEN FREE

Ürün Kodu		Ölçü(cm)		Fiyat	
Opak Kapak	Şeffaf Kapak			Opak Kapak	Şeffaf Kapak
910.2130.131.000	910.2130.132.000	21 x 30 x 13	20	686,00 TL	720,00 TL
910.2635.151.000	910.2635.152.000	26 x 35 x 15	12	926,00 TL	976,00 TL
910.2635.181.000	910.2635.182.000	26 x 35 x 18	12	971,00 TL	1.017,00 TL
910.3040.131.000	910.3040.132.000	30 x 40 x 13	10	1.162,00 TL	1.251,00 TL
910.3040.171.000	910.3040.172.000	30 x 40 x 17	8	1.170,00 TL	1.300,00 TL
910.3040.191.000	910.3040.192.000	30 x 40 x 19	8	1.326,00 TL	1.440,00 TL
910.3040.231.000	910.3040.232.000	30 x 40 x 23	8	1.365,00 TL	1.458,00 TL
910.4050.201.000	910.4050.202.000	40 x 50 x 20	6	1.998,00 TL	2.220,00 TL
910.4060.201.000	910.4060.202.000	40 x 60 x 20	6	2.155,00 TL	2.747,00 TL
910.5070.251.000	910.5070.252.000	50 x 70 x 25	4	3.367,00 TL	3.833,00 TL



910.2130.132.000



910.2635.151.000



910.3040.232.000



910.4050.201.000

Perdeli

IP65

HALOJEN FREE

Ürün Kodu		Ölçü(cm)	Açıklama		Fiyat	
Opak Kapak	Şeffaf Kapak				Opak Kapak	Şeffaf Kapak
920.2130.131.016	920.2130.132.016	21 x 30 x 13	2 x 8 Sigorta	20	1.080,00 TL	1.154,00 TL
920.2635.151.018	920.2635.152.018	26 x 35 x 15	2 x 9 Sigorta	12	1.265,00 TL	1.377,00 TL
920.3040.131.024	920.3040.132.024	30 x 40 x 13	3 x 8 Sigorta	10	1.558,00 TL	1.724,00 TL
920.3040.171.024	920.3040.172.024	30 x 40 x 17	3 x 8 Sigorta	8	1.601,00 TL	1.775,00 TL
920.4050.201.048	920.4050.202.048	40 x 50 x 20	3 x 16 Sigorta	6	2.886,00 TL	3.145,00 TL
920.4060.201.064	920.4060.202.064	40 x 60 x 20	4 x 16 Sigorta	6	3.240,00 TL	3.816,00 TL
920.5070.251.100	920.5070.252.100	50 x 70 x 25	5 x 20 Sigorta	4	4.515,00 TL	5.163,00 TL



920.2635.151.018



920.3040.172.024



920.4050.201.048



920.4060.202.064

Perdeli + Kompakt Şalterli

IP65

HALOJEN FREE

Ürün Kodu		Ölçü(cm)	Açıklama		Fiyat	
Opak Kapak	Şeffaf Kapak				Opak Kapak	Şeffaf Kapak
922.4050.201.032	922.4050.202.032	40 x 50 x 20	2 x 16 Sigorta + 1 Kompakt Şalter	6	2.886,00 TL	3.145,00 TL
922.4060.201.048	922.4060.202.048	40x 60 x 20	3 x 16 Sigorta + 1 Kompakt Şalter	6	3.240,00 TL	3.816,00 TL
922.5070.251.080	922.5070.252.080	50 x 70 x 25	4 x 20 Sigorta + 1 Kompakt Şalter	4	4.515,00 TL	5.163,00 TL



922.4050.202.032



922.4060.201.048



922.5070.252.080

Monofoze Sayaçlı

IP65

HALOJEN FREE

Ürün Kodu		Ölçü(cm)	Açıklama		Fiyat	
Opak Kapak	Şeffaf Kapak				Opak Kapak	Şeffaf Kapak
930.2130.131.003	930.2130.132.003	21 x 30 x 13	1 Sayaç + 3 Sigorta	20	1.080,00 TL	1.154,00 TL
930.2635.151.003	930.2635.152.003	26x 35 x 15	1 Sayaç + 3 Sigorta	12	1.265,00 TL	1.377,00 TL

Monofoze Sayaç+ Dağıtımlı

IP65

HALOJEN FREE

Ürün Kodu		Ölçü(cm)	Açıklama		Fiyat	
Opak Kapak	Şeffaf Kapak				Opak Kapak	Şeffaf Kapak
931.3040.131.013	931.3040.132.013	30 x 40 x 13	1 Sayaç + 13 Sigorta	10	1.558,00 TL	1.724,00 TL
931.3040.171.013	931.3040.172.013	30 x 40 x 17	1 Sayaç + 13 Sigorta	8	1.601,00 TL	1.775,00 TL
931.4050.201.224	931.4050.202.224	40 x 50 x 20	2 Sayaç + 24 Sigorta	6	2.886,00 TL	3.145,00 TL



930.2635.151.003



931.4050.202.224

Trifaze Sayaçlı

IP65

HALOJEN FREE

Ürün Kodu		Ölçü(cm)	Açıklama	📦	Fiyat	
Opak Kapak	Şeffaf Kapak				Opak Kapak	Şeffaf Kapak
935.3040.131.010	935.3040.132.010	30 x 40 x 13	1 Sayaç + 10 Sigorta	10	1.558,00 TL	1.724,00 TL
935.3040.171.010	935.3040.172.010	30 x 40 x 17	1 Sayaç + 10 Sigorta	8	1.601,00 TL	1.775,00 TL
935.4050.201.008	935.4050.202.008	40 x 50 x 20	1 Sayaç + 8 Sigorta	6	2.886,00 TL	3.145,00 TL
935.4060.201.008	935.4060.202.008	40 x 60 x 20	1 Sayaç + 8 Sigorta	6	3.240,00 TL	3.816,00 TL
935.5070.251.010	935.5070.252.010	50 x 70 x 25	1 Sayaç + 10 Sigorta	4	4.515,00 TL	5.163,00 TL
942.5070.251.000	942.5070.252.000	50 x 70 x 25	Kompakt Şalter + Kaçak Akım + Akım Trafo	4	4.515,00 TL	5.163,00 TL



936.4050.202.008



935.4060.201.008



935.5070.252.010



942.5070.251.000

Trifaze Sayaç + Dağıtım

IP65

HALOJEN FREE

Ürün Kodu		Ölçü(cm)	Açıklama	📦	Fiyat	
Opak Kapak	Şeffaf Kapak				Opak Kapak	Şeffaf Kapak
936.4050.201.024	936.4050.202.024	40 x 50 x 20	1 Sayaç + 24 Sigorta	6	2.886,00 TL	3.145,00 TL
936.4060.201.040	936.4060.202.040	40 x 60 x 20	1 Sayaç + 40 Sigorta	6	3.240,00 TL	3.816,00 TL
936.5070.251.068	936.5070.252.068	50 x 70 x 25	1 Sayaç + 68 Sigorta	4	4.515,00 TL	5.163,00 TL



936.4050.202.024



936.4060.201.040



936.5070.252.068

Şantiye Panoları

IP65

HALOJEN FREE

Ürün Kodu		Ölçü(cm)	Açıklama		Fiyat	
Opak Kapak	Şeffaf Kapak				Opak Kapak	Şeffaf Kapak
965.4060.201.024	965.4060.202.024	40 x 60 x 20	1 Trifaze Sayaç + 24 Sigorta + 3 Priz Yeri	6	3.240,00 TL	3.816,00 TL
965.5070.251.048	965.5070.252.048	50 x 70 x 25	1 Trifaze Sayaç + 48 Sigorta + 4 Priz Yeri	4	4.515,00 TL	5.163,00 TL
965.5070.251.028	965.5070.252.028	50 x 70 x 25	1 Trifaze Sayaç + 28 Sigorta + 8 Priz Yeri	4	4.515,00 TL	5.163,00 TL
966.4050.201.032	966.4050.202.032	40 x 50 x 20	32 Sigorta + 3 Priz Yeri	6	2.886,00 TL	3.145,00 TL
966.4060.201.048	966.4060.202.048	40 x 60 x 20	48 Sigorta + 3 Priz Yeri	6	3.240,00 TL	3.816,00 TL
966.4060.201.032	966.4060.202.032	40 x 60 x 20	32 Sigorta + 6 Priz Yeri	6	3.240,00 TL	3.816,00 TL
966.5070.251.060	966.5070.252.060	50 x 70 x 25	60 Sigorta + 8 Priz Yeri	4	4.515,00 TL	5.163,00 TL



966.4050.202.032



966.4060.201.032



965.4060.202.024



965.5070.251.028

Kofra Panoları

IP65

HALOJEN FREE

Ürün Kodu		Ölçü(cm)		Fiyat	
Opak Kapak	Şeffaf Kapak			Opak Kapak	Şeffaf Kapak
923.2635.151.000	923.2635.152.000	26 x 35 x 15	12	1.082,00 TL	1.177,00 TL
923.3040.171.000	923.3040.172.000	30 x 40 x 17	8	1.321,00 TL	1.463,00 TL
923.4050.201.000	923.4050.202.000	40 x 50 x 20	6	2.251,00 TL	2.453,00 TL



923.2635.151.000



923.3040.171.000



923.4050.202.000

Sulama Panoları

IP65

HALOJEN FREE

Ürün Kodu		Ölçü(cm)	Açıklama		Fiyat	
Opak Kapak	Şeffaf Kapak				Opak Kapak	Şeffaf Kapak
960.4050.201.000	960.4050.202.000	40 x 50 x 20	Voltmetre + Ampermetre + Sinyal	6	2.886,00 TL	3.145,00 TL
960.4060.201.000	960.4060.202.000	40x 60 x 20	Voltmetre + Ampermetre + Sinyal	6	3.330,00 TL	3.922,00 TL
960.5070.251.000	960.5070.252.000	50 x 70 x 25	Voltmetre + Ampermetre + Sinyal	4	4.773,00 TL	5.458,00 TL



960.4050.202.000



960.4060.201.000



960.5070.252.000

Pano Aksesuarları

Ürün Kodu	Açıklama		Fiyat
740.020.000	(40 x 50 - 40 x 60 - 50 x 70) Pano Ayak	1	352,00 TL
740.030.026	26 x 35 Pano Çatı	1	139,00 TL
740.030.030	30 x 40 Pano Çatı	1	181,00 TL
740.030.045	(40 x 50 - 40 x 60) Pano Çatı	1	194,00 TL
740.030.050	50 x 70 Pano Çatı	1	259,00 TL



**M150 Plastik Gövdeli
Kablosuz Makaralar**

Ürün Kodu

Açıklama



Fiyat



150.000.04

4(1x16A) Şebeke

10

850,00 TL



150.000.04.T

4(1x16A) Şebeke + Termikli

10

935,00 TL

**M100 Metal Gövdeli Kablosuz
Makaralar - Sinyal Ledli**

Ürün Kodu

Açıklama



Fiyat



100.000.004

4(1x16A) Şebeke

10

1.350,00 TL



100.000.004.T

4(1x16A) Şebeke + Termikli

10





1.435,00 TL

Makara Cinsi	Kablo Kesiti	3x1,5 TTR	3x2,5 TTR	3x4 TTR	4x1,5 TTR	4x2,5 TTR	4x4 TTR	5x1,5 TTR	5x2,5 TTR	5x4 TTR
M100		50	40	30	-	-	-	-	-	-
M120		100	75	60	80	65	45	75	50	40
M150		60	50	40	-	-	-	-	-	-

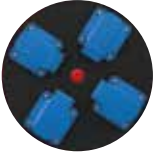
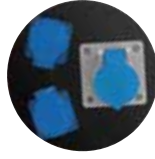
M120 Kablosuz Makaralar

M120 Metal Gövdeli

Ürün Kodu	12X.000.004	12X.000.004.T	12X.000.004E	12X.316.012	12X.416.012
Makara Göbekleri					
Açıklama	4(1x16A) Şebeke + Sinyal	4(1x16A) Şebeke + Sinyal + Termikli	4(1x16A) Pano Prizi + Sinyal	1(3x16A) CEE + 2(1x16A) Pano Prizi	1(4x16A) CEE + 2(1x16A) Pano Prizi
Makara Fiyat	1.700,00 TL	1.785,00 TL	1.844,00 TL	1.887,00 TL	1.932,00 TL
Tekerlekli Makara Fiyat	2.500,00 TL	2.585,00 TL	2.544,00 TL	2.587,00 TL	2.682,00 TL
Arabalı Makara Fiyat	2.750,00 TL	2.835,00 TL	2.794,00 TL	2.837,00 TL	2.882,00 TL

Ürün Kodu	12X.516.012	12X.425.012	12X.332.012	12X.432.012	12X.532.012
Makara Göbekleri					
Açıklama	1(5x16A) CEE + 2(1x16A) Pano Prizi	1(4x25A) CEE + 2(1x16A) Pano Prizi	1(3x32A) CEE + 2(1x16A) Pano Prizi	1(4x32A) CEE + 2(1x16A) Pano Prizi	1(5x32A) CEE + 2(1x16A) Pano Prizi
Makara Fiyat	1.992,00 TL	1.808,00 TL	1.992,00 TL	2.037,00 TL	2.062,00 TL
Tekerlekli Makara Fiyat	2.692,00 TL	2.508,00 TL	2.692,00 TL	2.737,00 TL	2.762,00 TL
Arabalı Makara Fiyat	2.942,00 TL	2.758,00 TL	2.942,00 TL	2.987,00 TL	3.012,00 TL

Makara Cinsi	Kablo Kesiti	3x1,5 TTR	3x2,5 TTR	3x4 TTR	4x1,5 TTR	4x2,5 TTR	4x4 TTR	5x1,5 TTR	5x2,5 TTR	5x4 TTR
M120		100	75	60	80	65	45	75	50	40

X = 0 Borulu Makara X = 1 Arabalı Makara X = 2 Tekerlekli Makara



120.000.004.T





122.416.012





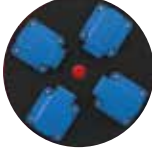

121.425.012

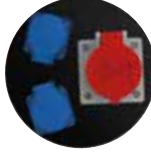
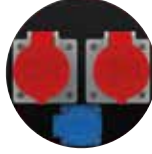
M130 Kablosuz Makaralar

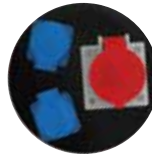
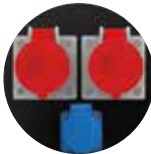
M130 Metal Gövdeli

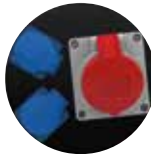
Ürün Kodu	13X.000.004	13X.416.012	13X.416.021	13X.516.012	13X.516.021
Makara Göbekleri					
Açıklama	4(1x16A) Pano Prizi + Sinyal	1(4x16A) CEE + 2(1x16A) Pano Prizi	2(4x16A) CEE + 1(1x16A) Pano Prizi	1(5x16A) CEE + 2(1x16A) Pano Prizi	2(5x16A) CEE + 1(1x16A) Pano Prizi
Makara Fiyat	2.444,00 TL	2.532,00 TL	2.706,00 TL	2.592,00 TL	2.826,00 TL
Tekerlekli Makara Fiyat	3.134,00 TL	3.222,00 TL	3.396,00 TL	3.282,00 TL	3.516,00 TL
Arabalı Makara Fiyat	3.384,00 TL	3.472,00 TL	3.646,00 TL	3.532,00 TL	3.766,00 TL

Ürün Kodu	13X.425.012	13X.425.021	13X.332.012	13X.432.012	13X.532.012
Makara Göbekleri					
Açıklama	1(4x25A) CEE + 2(1x16A) Pano Prizi	2(4x25A) CEE + 1(1x16A) Pano Prizi	1(3x32A) CEE + 2(1x16A) Pano Prizi	1(4x32A) CEE + 2(1x16A) Pano Prizi	1(5x32A) CEE + 2(1x16A) Pano Prizi
Makara Fiyat	2.408,00 TL	2.458,00 TL	2.592,00 TL	2.637,00 TL	2.662,00 TL
Tekerlekli Makara Fiyat	3.098,00 TL	3.148,00 TL	3.282,00 TL	3.327,00 TL	3.352,00 TL
Arabalı Makara Fiyat	3.348,00 TL	3.398,00 TL	3.532,00 TL	3.577,00 TL	3.602,00 TL

Makara Cinsi	Kablo Kesiti	3x1,5 TTR	3x2,5 TTR	3x4 TTR	4x1,5 TTR	4x2,5 TTR	4x4 TTR	5x1,5 TTR	5x2,5 TTR	5x4 TTR
M130		120	100	75	100	80	55	100	70	50

X = 0 Borulu Makara X = 1 Arabalı Makara X = 2 Tekerlekli Makara



130.516.012







132.532.012



131.516.021

M140 Kablosuz Makaralar

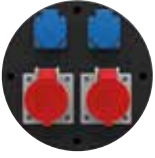
M140 Metal Gövdeli

Ürün Kodu	14X.416.022	14X.516.022	14X.425.022	14X.432.022	14X.532.022
Makara Göbekleri					
Açıklama	2(4x16A) CEE + 2(1x16A) Pano Prizi	2(5x16A) CEE + 2(1x16A) Pano Prizi	2(4x25A) CEE + 2(1x16A) Pano Prizi	2(4x32A) CEE + 2(1x16A) Pano Prizi	2(5x32A) CEE + 2(1x16A) Pano Prizi
Makara Fiyat	3.192,00 TL	3.312,00 TL	2.944,00 TL	3.402,00 TL	3.452,00 TL
Tekerlekli Makara Fiyat	3.842,00 TL	3.962,00 TL	3.594,00 TL	4.052,00 TL	4.102,00 TL
Arabalı Makara Fiyat	4.092,00 TL	4.212,00 TL	3.844,00 TL	4.302,00 TL	4.352,00 TL

Makara Cinsi	Kablo Kesiti	3x1,5 TTR	3x2,5 TTR	3x4 TTR	4x1,5 TTR	4x2,5 TTR	4x4 TTR	5x1,5 TTR	5x2,5 TTR	5x4 TTR
M100		50	40	30	-	-	-	-	-	-
M120		100	75	60	80	65	45	75	50	40
M130		120	100	75	100	80	55	100	70	50
M140		180	140	125	170	130	100	135	110	90
M150		60	50	40	-	-	-	-	-	-
M160		60	50	40	50	35	25	-	-	-

X = 0 Borulu Makara X = 1 Arabalı Makara X = 2 Tekerlekli Makara



140.432.022



142.516.022



141.532.022



TEM

Acil Aydınlatma

Sabit ve seyyar olarak kullanılabilen ürünümüz, elektrik kesintisinde otomatik devreye girer ve fabrikalar, otoparklar, uzun koridorlar gibi geniş kullanım alanına sahiptir.



200.127.100

Çift Spotlu Acil Aydınlatma
+ Şarj Göstergesi

	Çalışma Voltajı	Lamba	Renk Sıcaklığı	Şarj Süresi (Saat)	Çalışma Sıcaklığı	Koruma Sınıfı	Elektrik Sınıfı	Batarya Kapasitesi	Çalışma Süresi(dk)	Ürün Boyutları
Çift Spotlu Acil Aydınlatma	220-230V AC / 50-60Hz	2x9 Led	6000 - 6500 K	24	-10°C.... +40° C	IP 40	II	12V 2.3Ah Lead Acid Battery	180	355x135x400
Tek Spotlu Acil Aydınlatma	220-230V AC / 50-60Hz	2x9 Led	6000 - 6500 K	24	-10°C.... +40° C	IP 40	II	3,6V 1800mAh NiCd Battery	120	135x100x365



Acil aydınlatma modelleri için fiyat sorunuz.

Seyyar Lamba - Baladoz

Anahtarlı	Ürün Kodu	Açıklama		Fiyat
	785.000.010	Kablosuz	10	264,00 TL
	785.105.010	5m. Kablolu	5	509,00 TL
	785.110.010	10m. Kablolu	5	732,00 TL
	785.115.010	15m. Kablolu	5	956,00 TL
	785.120.010	20m. Kablolu	4	1.180,00 TL
	785.125.010	25m. Kablolu	4	1.404,00 TL

Anahtarsız	Ürün Kodu	Açıklama		Fiyat
	785.000.020	Kablosuz	10	234,00 TL
	785.105.020	5m. Kablolu	5	476,00 TL
	785.110.020	10m. Kablolu	5	692,00 TL
	785.115.020	15m. Kablolu	5	907,00 TL
	785.120.020	20m. Kablolu	4	1.119,00 TL
	785.125.020	25m. Kablolu	4	1.343,00 TL

Seyyar Lamba - Çanaklı Baladoz

Anahtarlı	Ürün Kodu	Açıklama		Fiyat
	786.000.010	Kablosuz	10	894,00 TL
	786.107.010	7.5m. Kablolu	5	1.199,00 TL

Anahtarsız	Ürün Kodu	Açıklama		Fiyat
	786.000.020	Kablosuz	10	875,00 TL
	786.107.020	7.5m. Kablolu	5	1.168,00 TL

Kablolar

725.315.113
Çift Topraklı Fişli Kablo
3G 1,5 H0VV-F 3m.



725.325.113
Çift Topraklı Fişli Kablo
3G 2,5 H0VV-F 3m.



725.310.212
Güç Kablosu
3G 1 H0VV-F 1,8m.



725.315.123
İngiliz Fişli Kablo
3G 1,5 H0VV-F 3m.

Kablolar için fiyat sorunuz.

Kablo Bağı**Ürün Kodu****Açıklama****Fiyat**

736.230.210	2.5 x 100	100	0,33 TL
736.230.214	2.5 x 140	100	0,48 TL
736.230.220	2.5 x 200	100	0,70 TL
736.230.315	3.6 x 150	100	0,79 TL
736.230.320	3.6 x 205	100	1,03 TL
736.230.325	3.6 x 250	100	1,27 TL
736.230.330	3.6 x 300	100	1,55 TL
736.230.337	3.6 x 370	100	1,97 TL
736.230.420	4.8 x 200	100	1,47 TL
736.230.425	4.8 x 250	100	1,77 TL
736.230.430	4.8 x 300	100	2,41 TL
736.230.435	4.8 x 350	100	2,54 TL
736.230.440	4.8 x 400	100	2,93 TL
736.230.845	8 x 450	100	5,69 TL
736.230.855	8 x 550	100	7,44 TL
736.230.976	9 x 762	100	15,97 TL
736.230.994	9 x 940	100	18,38 TL



İskan ERDOĞMUŞ
Satış Koordinatörü

İstanbul Anadolu Yakası, Kocaeli, Sakarya, Düzce
Bolu, Ankara, Bursa, Muğla, Antalya, Eskişehir,
Akdeniz Bölgesi, Güney Doğu Anadolu Bölgesi,
Karadeniz Bölgesi, İç Anadolu Bölgesi,

iskanerdogmus@temteknik.com
0532 417 31 86

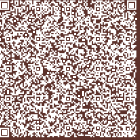

Furkan ERDOĞMUŞ
Satış Sorumlusu

İstanbul Avrupa Yakası, Trakya Bölgesi, Çanakkale
Balıkesir, Manisa, İzmir, Aydın, Denizli

furkanerdogmus@temteknik.com
0531 381 04 38

TEM®

TEM TEKNİK ELEKTRİK MALZEMELERİ SANAYİ VE TİCARET ANONİM ŞİRKETİ

 Selimpaşa Ortaköy Sanayi Bölgesi, İltar Bulvarı, Mor Menekşe Sok, No:5 34590
SİLİVRİ / İSTANBUL / TÜRKİYE

 +90 212 485 19 00

 +90 212 485 15 33

 www.temteknik.com

 info@temteknik.com